

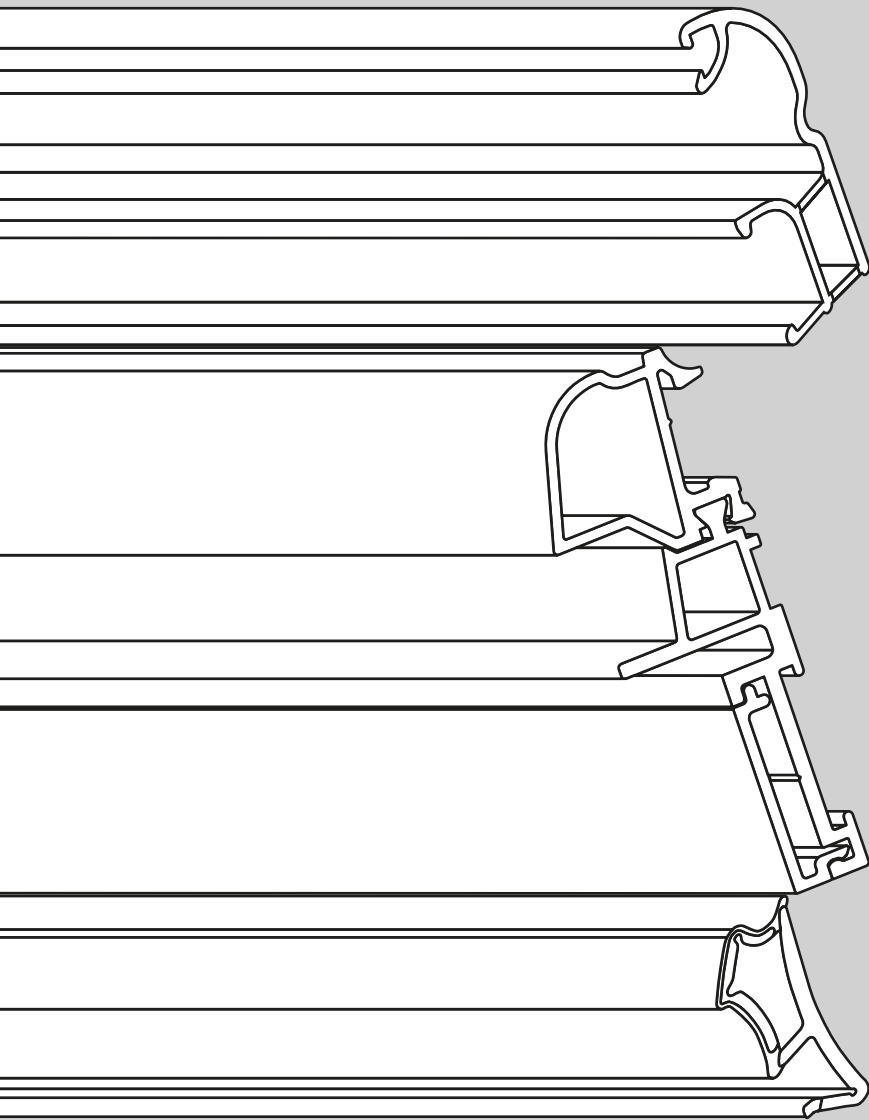

ACCESSORI
CASCADING
FREUD.



GOCCIOLATOI

SOGLIE

SOGLIE GUTMANN

GUARNIZIONI

ACCESSORI

WEATHER BARS

THRESHOLDS

GUTMANN THRESHOLDS

GASKETS

ACCESSORIES



ACCESSORI
CASCADING
FREUD.

CATALOGO 2019/ 5
CATALOGUE 2019/ 5

GOCCIOLATOI
SOGLIE
SOGLIE GUTMANN
GUARNIZIONI
ACCESSORI

WEATHER BARS
THRESHOLDS
GUTMANN THRESHOLDS
GASKETS
ACCESSORIES

GUIDA ALLA LETTURA DEI CODICI
READING GUIDE OF CODES

PRG	311	A	01	0024	GOCCIOLATOI
					WEATHER BARS
				quantità confezione quantity package	
			revisione review		
		colore colour			
		A = argento silver B = bronzo chiaro light bronze C = bronzo scuro dark bronze F = bianco white H = bronzo medio middle bronze			
					profilo alluminio aluminium profile
					articolo item

PRT	290	A	01	0024	SOGLIE
					THRESHOLDS
				quantità confezione quantity package	
			revisione review		
		colore colour			
		A = argento silver B = bronzo chiaro light bronze C = bronzo scuro dark bronze F = bianco white H = bronzo medio middle bronze			
					profilo alluminio aluminium profile
					articolo item

altri colori
other colours
A = argento + ABS nero silver + ABS black
G = argento + ABS grigio silver + ABS grey
F = bianco + ABS nero white + ABS black

negli articoli
for items
PRT028-020024
PRT029-020024
PRT038-010024
PRT048-010024

GC	M	512	004	0220	GUARNIZIONI
					GASKETS
				quantità confezione quantity package	
			revisione review		
		colore colour			
		B = bianco white G = grigio grey M = marrone brown N = nero black T = trasparente transparent			
					profilo guarnizione gasket profile
					articolo item

le guarnizioni sono realizzate con diversi materiali, come indicato in tabella
gaskets are made of different materials as specified in the grid

materiali guarnizioni
gaskets materials
EPDM
PVC
SILICONE
TP-S
TPE
TPV

INDICE
TABLE OF CONTENTS

4	GOCCIOLATOI WEATHER BARS	22	SOGLIE THRESHOLDS	58	SOGLIE GUTMANN GUTMANN THRESHOLDS	68	GUARNIZIONI GASKETS
6	PRG311-010024	24	PRG024-010024	61	WESER 65 TI	70	GC-5120040220
8	PRG313-010024	26	PRG025-010024	.	WESER 75 TI	.	GL-5120010220
10	PRG317-010024	28	PRG290-010024	.	WESER 95 TI	.	GD-5120030280
12	PRG318-010024	30	PRG289-010024	.	TD 50	.	GE-5120010220
14	PRG333-010024	32	PRG028-010024	.	SH Weser	.	GF-5120010220
16	PRG334-010024	34	PRG029-010024	62	WESER 65/20 TI	71	GC-6040030400
18	PRG335-010024	36	SOGLIE A TAGLIO TERMICO THERMAL CUT THRESHOLDS	.	WESER 75/20 TI	.	GL-6040010400
20	PRG367-010024			.	WESER 95/20 TI	.	GC-6100030340
		36	PRT290-010024	63	WESER D 8	.	GL-6100010340
		38	PRT289-010024	.	WESER D 8 ABS	.	GD-6100030310
		40	PRT027-010024	.	WESER TD 8/11	.	GF-6100010340
		42	PRT028-010024	.	WESER SH 70	.	GD-1860010220
		44	PRT028-020024	64	WESER BS 21.4	73	GA-2060010220
		45	PRT028-020024-S			.	GA-8600020200
		46	PRT029-010024	64	SOGLIE DA INTERNO THRESHOLDS FOR INTERIOR	.	GE-8600010200
		48	PRT029-020024			.	GA-9100030450
		49	PRT029-020024-S	64	INT P 60-15	.	GA-9190020215
		50	PRT038-010024	.	INT M5x37	74	GA-9070020480
		51	PRT038-010024-S	.	DICHTUNG TD 15	.	GA-9080020480
		52	PRT048-010024	.	INT TD 20	.	GE-5040030400
		53	PRT048-010024-S	.	INT TD 32	.	GV-5040010200
		54	ACCESSORI ACCESSORIES	65	ALZANTE SCORRECOLE LIFTING SLIDING DOOR	.	GA-4450010350
		54	PRG323-010024			.	GC-4110020320
		.	FPA315A010200	65	MV 26.11	75	GD-4110010300
		55	FP-333A010200	.	HA 3010	.	GC-4140020240
		.	PRT030-010024	.	RB 1	.	GC-4150020250
		56	PRT031X010024	.	RB 2	.	GA-4180010225
		.	PRT032X010024	.	RB 2 MS	76	GC-4180020180
		.	PRT032X010025	66	GRONDALINI WEATHER BAR SILL	.	GA-5150010225
		57	PFV1614010024			.	GD-3100020400
		.	PFV2714010024	66	FP 18	.	GA-3120020300
		.	GAT3000010300	.	FP 20	.	GA-3125020300
		.	PAMUSS10	.	CLIP FP 16/20	.	GA-3310020100
				.	FP/18	77	GA-3320020340
				.	FP/20	.	GE-4300020450
						.	GE-2140010500
				66	FP 18	78	GUARNIZIONI PORTE GASKETS FOR DOORS
				.	FP 20	.	GP-8300020250
				.	CLIP FP 16/20	.	GA-8300010300
				.	FP/18	.	GP-8310020340
				.	FP/20	.	GP-8400020300
						.	GE-8400010250
						.	GE-8460010250
						79	GP-8470020270
						.	GP-8500020250
						80	SPECIALI E ACCESSORI SPECIALS AND ACCESSORIES
						.	GP-1300010200
						.	GAX8610010322
						.	GS-6350010200
						81	GA-3630010300
						.	4104/VR
						.	4104/YR
						.	FP-512A010200

GOCCIOLATOI
WEATHER BARS



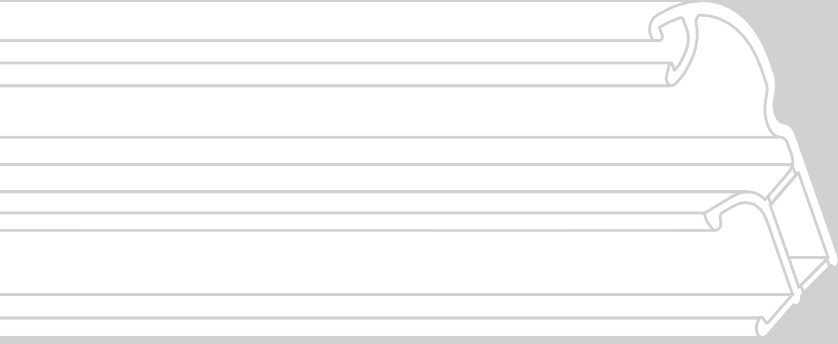

GOCCIOLATO1
WEATHER BARS

PRG311-010024

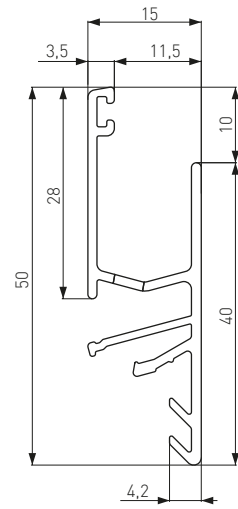
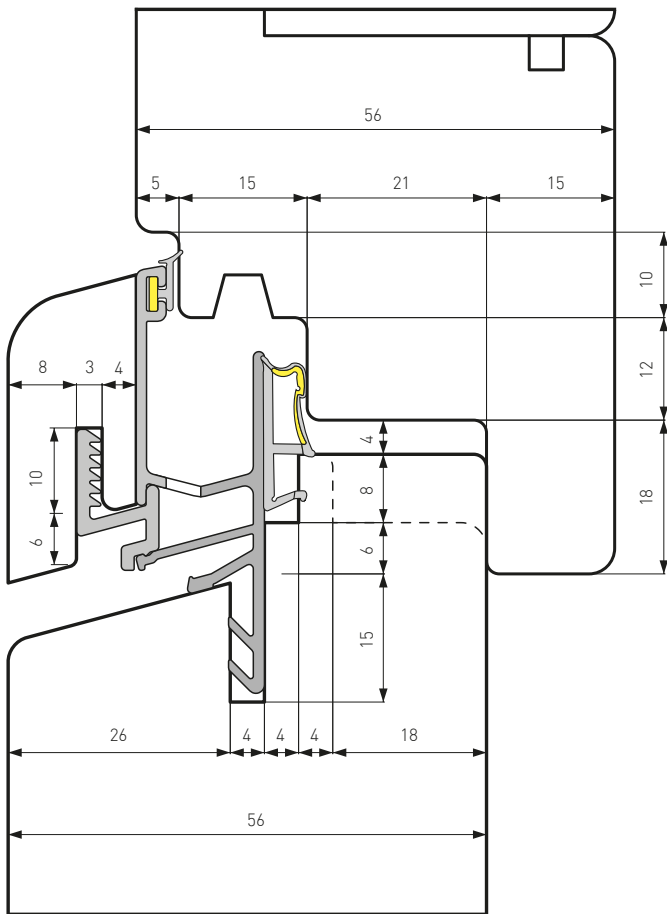

CASCADING FREUD

CE Ermetic



ACCESSORI ACCESSORIES

terminale end cover	FP-311A010200	↘ p. 7
clip clip holder	FPA315A010200	↘ p. 54
guarnizione gasket	GA-8600020200	↘ p. 72
	{ GC-5120040220	↘ p. 70
	{ GD-5120030280	↘ p. 70
grondalino weather bar sill	PRG323-010024	↘ p. 54

PRG311-010024	CODICE CODE	COLORE COLOUR	CF PK
	PRG311A010024	argento silver	24 ML
	PRG311B010024	bronzo chiaro light bronze	24 ML
	PRG311C010024	bronzo scuro dark bronze	24 ML
	PRG311H010024	bronzo medio middle bronze	24 ML
	PRG311S010024	RAL 9010 opaco matt	24 ML

ACCESSORI PRG311
ACCESSORIES PRG311

PRG323-010024	GRONDALINO WEATHER BAR SILL		COLORE COLOUR	CF PK
	ALU	PRG323A010024	argento silver	24 ML
	ALU	PRG323B010024	bronzo chiaro light bronze	24 ML
	ALU	PRG323C010024	bronzo scuro dark bronze	24 ML
	ALU	PRG323F010024	bianco white	24 ML
	ALU	PRG323H010024	bronzo medio middle bronze	24 ML

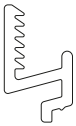
FPA315A010200	CLIP CLIP HOLDER		COLORE COLOUR	CF PK
	ALU	FPA315A010200	grezzo raw	200 PZ

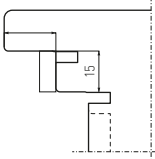
FP-311A010200	TERMINALE END COVER		COLORE COLOUR	CF PK
	TPE	FPB311A010200	bianco white	200 PZ
	TPE	FPN311A010200	marrone brown	200 PZ

PRG313-010024

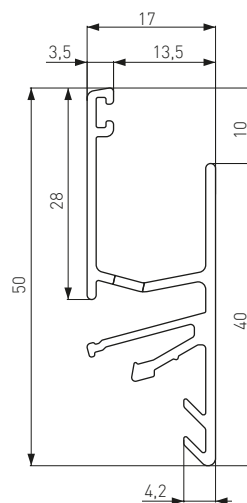
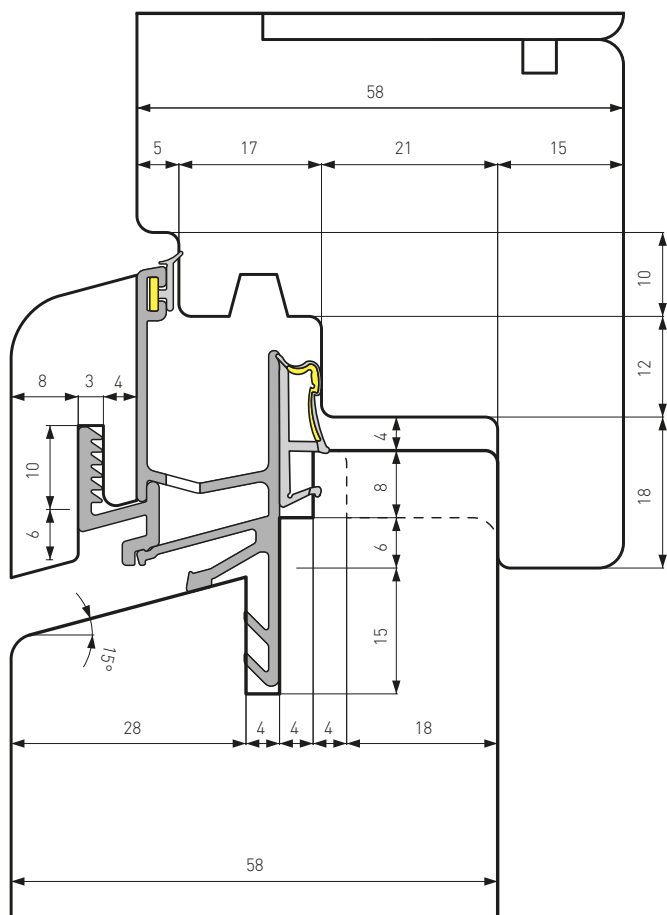

CASCADING FREUD

CE Ermetic 17



ACCESSORI ACCESSORIES

terminale end cover	FP-313A010200	➤ p. 9
clip clip holder	FPA315A010200	➤ p. 54
guarnizione gasket	GA-8600020200	➤ p. 72
	{ GC-5120040220	➤ p. 70
	{ GD-5120030280	➤ p. 70
grondalino weather bar sill	PRG323-010024	➤ p. 54

PRG313-010024	CODICE CODE	COLORE COLOUR	CF PK
	PRG313A010024	argento silver	24 ML
	PRG313B010024	bronzo chiaro light bronze	24 ML
	PRG313C010024	bronzo scuro dark bronze	24 ML
	PRG313F010024	RAL 9016 lucido gloss	24 ML
	PRG313H010024	bronzo medio middle bronze	24 ML

ACCESSORI PRG313
PRG313 ACCESSORIES

PRG323-010024	GRONDALINO WEATHER BAR SILL		COLORE COLOUR	CF PK
	ALU	PRG323A010024	argento silver	24 ML
	ALU	PRG323B010024	bronzo chiaro light bronze	24 ML
	ALU	PRG323C010024	bronzo scuro dark bronze	24 ML
	ALU	PRG323F010024	bianco white	24 ML
	ALU	PRG323H010024	bronzo medio middle bronze	24 ML

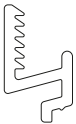
FPA315A010200	CLIP CLIP HOLDER		COLORE COLOUR	CF PK
	ALU	FPA315A010200	grezzo raw	200 PZ

FP-313A010200	TERMINALE END COVER		COLORE COLOUR	CF PK
	TPE	FPB313A010200	bianco white	200 PZ
	TPE	FPN313A010200	marrone brown	200 PZ

GA-8600020200	GUARNIZIONE GASKET		COLORE COLOUR	CF PK
	TP-S	GAB8600020200	bianco white	200 ML
	TP-S	GAM8600020200	marrone brown	200 ML
	TP-S	GAN8600020200	nero black	200 ML

PRG317-010024

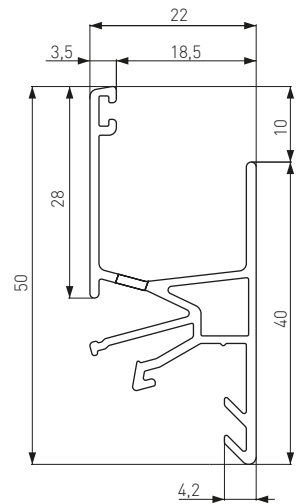
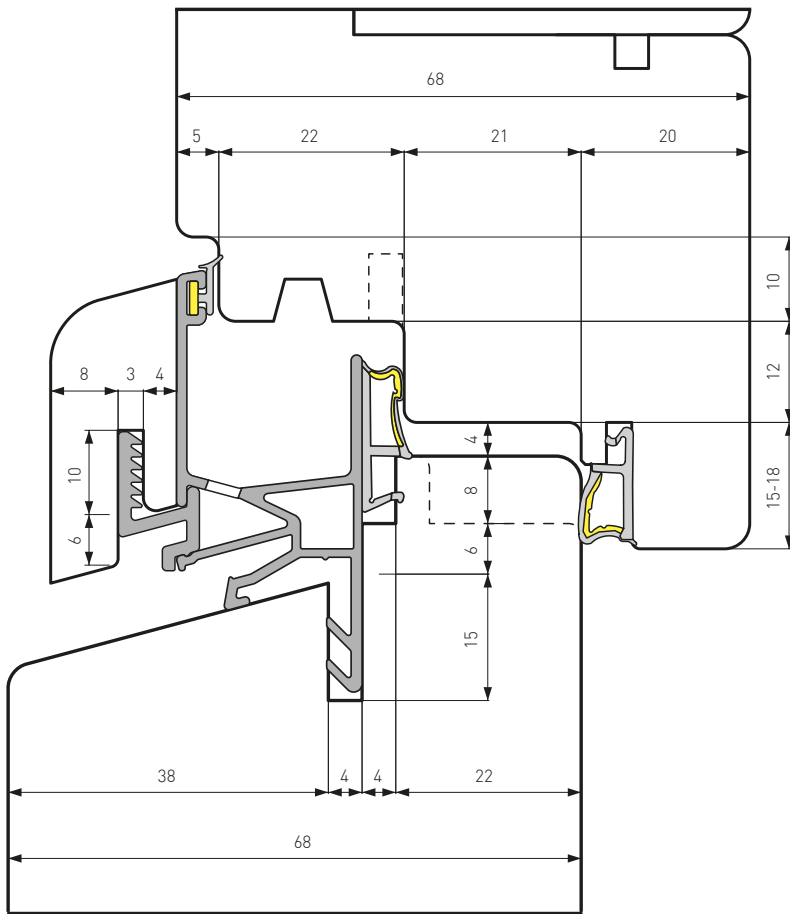

CASCADING FREUD

CE Euronorm



ACCESSORI ACCESSORIES

terminale end cover	FP-317A010200	↘ p. 11
clip clip holder	FPA315A010200	↘ p. 54
guarnizione gasket	GA-8600020200	↘ p. 72
{	GC-5120040220	↘ p. 70
{	GD-5120030280	↘ p. 70
{	GC-6100030340	↘ p. 71
{	GD-6100030310	↘ p. 71
grondalino weather bar sill	PRG323-010024	↘ p. 54

PRG317-010024	CODICE CODE	COLORE COLOUR	CF PK
	PRG317A010024	argento silver	24 ML
	PRG317B010024	bronzo chiaro light bronze	24 ML
	PRG317C010024	bronzo scuro dark bronze	24 ML
	PRG317F010024	RAL 9016 lucido gloss	24 ML
	PRG317H010024	bronzo medio middle bronze	24 ML
	PRG317S010024	RAL 9010 opaco matt	24 ML

ACCESSORI PRG317
PRG317 ACCESSORIES

PRG323-010024	GRONDALINO WEATHER BAR SILL		COLORE COLOUR	CF PK
	ALU	PRG323A010024	argento silver	24 ML
	ALU	PRG323B010024	bronzo chiaro light bronze	24 ML
	ALU	PRG323C010024	bronzo scuro dark bronze	24 ML
	ALU	PRG323F010024	bianco white	24 ML
	ALU	PRG323H010024	bronzo medio middle bronze	24 ML

FPA315A010200	CLIP CLIP HOLDER		COLORE COLOUR	CF PK
	ALU	FPA315A010200	grezzo raw	200 PZ

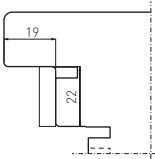
FP-317A010200	TERMINALE END COVER		COLORE COLOUR	CF PK
	TPE	FPB317A010200	bianco white	200 PZ
	TPE	FPN317A010200	marrone brown	200 PZ

GA-8600020200	GUARNIZIONE GASKET		COLORE COLOUR	CF PK
	TP-S	GAB8600020200	bianco white	200 ML
	TP-S	GAM8600020200	marrone brown	200 ML
	TP-S	GAN8600020200	nero black	200 ML

PRG318-010024

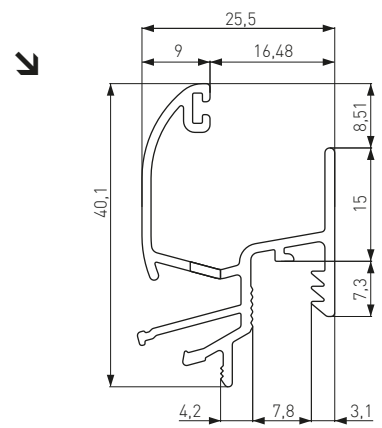
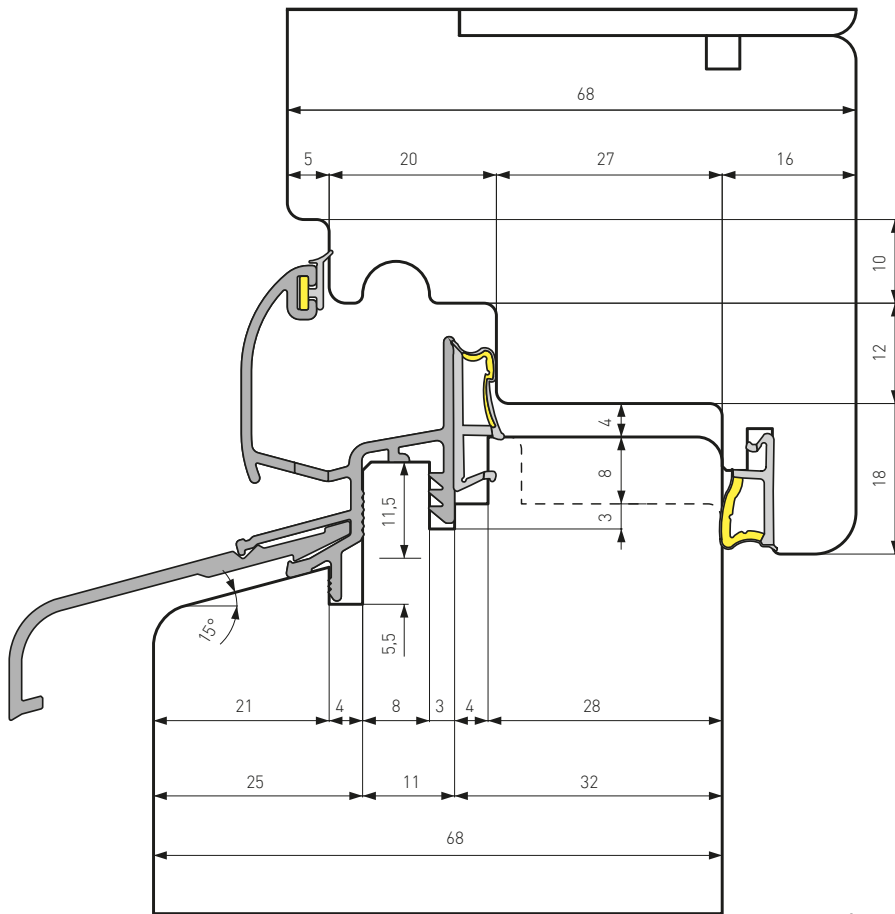

CASCADING FREUD

CE Euronorm C-13

ACCESSORI ACCESSORIES

terminale end cover	FP-318A010200	↘ p. 13
guarnizione gasket	GA-8600020200	↘ p. 72
{	GC-5120040220	↘ p. 70
{	GD-5120030280	↘ p. 70
{	GC-6100030340	↘ p. 71
{	GD-6100030310	↘ p. 71
grondalino weather bar sill	PRG323-010024	↘ p. 54

PRG318-010024	CODICE CODE	COLORE COLOUR	CF PK
	PRG318A010024	argento silver	24 ML
	PRG318B010024	bronzo chiaro light bronze	24 ML
	PRG318C010024	bronzo scuro dark bronze	24 ML
	PRG318F010024	RAL 9016 lucido gloss	24 ML
	PRG318H010024	bronzo medio middle bronze	24 ML
	PRG318S010024	RAL 9010 opaco matt	24 ML

ACCESSORI PRG318
PRG318 ACCESSORIES

PRG323-010024	GRONDALINO WEATHER BAR SILL		COLORE COLOUR	CF PK
	ALU	PRG323A010024	argento silver	24 ML
	ALU	PRG323B010024	bronzo chiaro light bronze	24 ML
	ALU	PRG323C010024	bronzo scuro dark bronze	24 ML
	ALU	PRG323F010024	bianco white	24 ML
	ALU	PRG323H010024	bronzo medio middle bronze	24 ML

FP-318A010200	TERMINALE END COVER		COLORE COLOUR	CF PK
	TPE	FPB318A010200	bianco white	200 PZ
	TPE	FPN318A010200	marrone brown	200 PZ
	TPE	FPB318B010200	bianco white	200 PZ
	TPE	FPN318B010200	marrone brown	200 PZ

GA-8600020200	GUARNIZIONE GASKET		COLORE COLOUR	CF PK
	TP-S	GAB8600020200	bianco white	200 ML
	TP-S	GAM8600020200	marrone brown	200 ML
	TP-S	GAN8600020200	nero black	200 ML

PRG333-010024

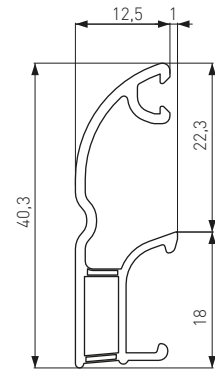
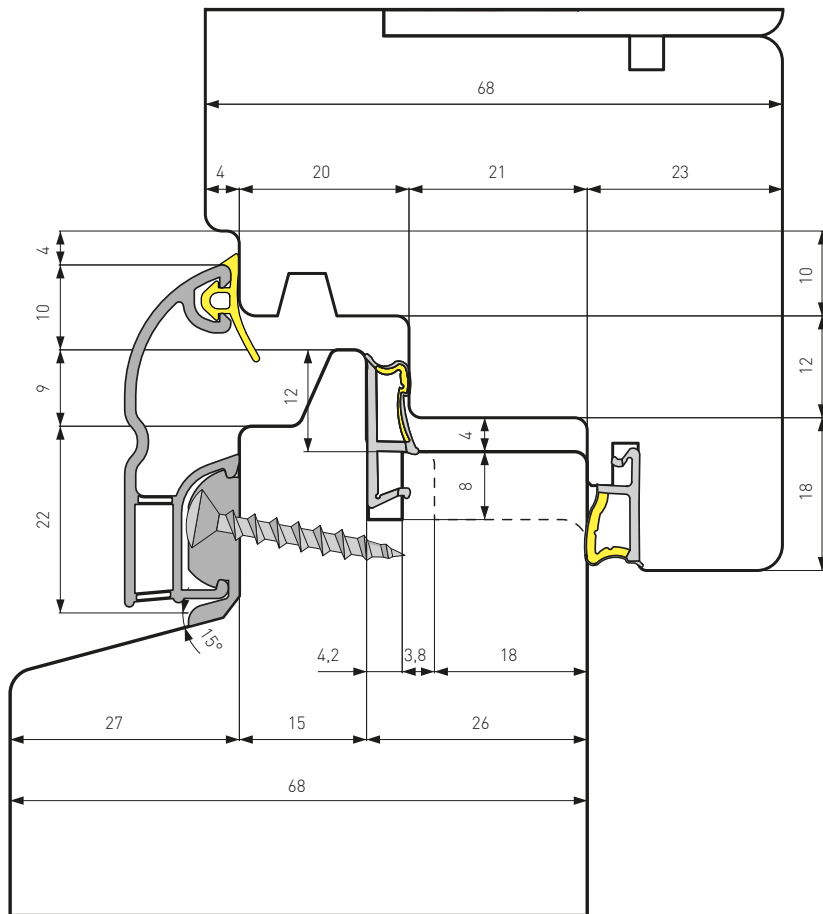

CASCADING FREUD

- CE Euronorm C-13
- CE Eurost
- CE Eurost 17
- CE Fox 92
- CE Freumex
- CE Freumex 17
- CE Freumex C-13
- CE Ghost



ACCESSORI ACCESSORIES

terminale end cover	FP-333-010200	➤ p. 15
clip clip holder	FPA333A010200	➤ p. 55
guarnizione gasket	GA-9100030450	➤ p. 72
{	GC-5120040220	➤ p. 70
{	GD-5120030280	➤ p. 70
{	GC-6100030340	➤ p. 71
{	GD-6100030310	➤ p. 71

PRG333-010024	CODICE CODE	COLORE COLOUR	CF PK
	PRG333A010024	argento silver	24 ML
	PRG333B010024	bronzo chiaro light bronze	24 ML
	PRG333C010024	bronzo scuro dark bronze	24 ML
	PRG333F010024	RAL 9016 lucido gloss	24 ML
	PRG333H010024	bronzo medio middle bronze	24 ML
	PRG333S010024	RAL 9010 opaco matt	24 ML

ACCESSORI PRG333
PRG333 ACCESSORIES

FP-333A010024	CLIP CLIP HOLDER		COLORE COLOUR	CF PK
	NYLON	FPA333A010200	neutro neutral	200 PZ

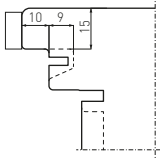
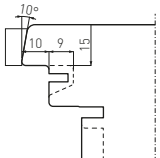
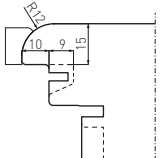
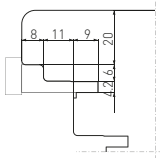
FP-333-010200	TERMINALE END COVER		COLORE COLOUR	CF PK
* 	TPE	FPB333A010200	bianco white	200 PZ
	TPE	FPG333A010200	grigio grey	200 PZ
	TPE	FPN333A010200	marrone brown	200 PZ
* diritto right				
** 	TPE	FPB333B010200	bianco white	200 PZ
	TPE	FPN333B010200	marrone brown	200 PZ
	** inclinato inclined			
*** 	TPE	FPB333C010200	bianco white	200 PZ
	TPE	FPN333C010200	marrone brown	200 PZ
	*** morbido soft			
**** 	TPE	FPB333D010200	bianco white	200 PZ
	TPE	FPG333D010200	grigio grey	200 PZ
	TPE	FPN333D010200	marrone brown	200 PZ
	**** compensazione compensation			

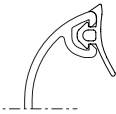
GA-9100030450	GUARNIZIONE GASKET		COLORE COLOUR	CF PK
	TP-S	GAB9100030450	bianco white	450 ML
	TP-S	GAG9100030450	grigio grey	450 ML
	TP-S	GAM9100030450	marrone brown	450 ML
	TP-S	GAN9100030450	nero black	450 ML

PRG334-010024

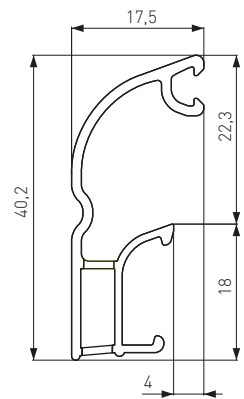
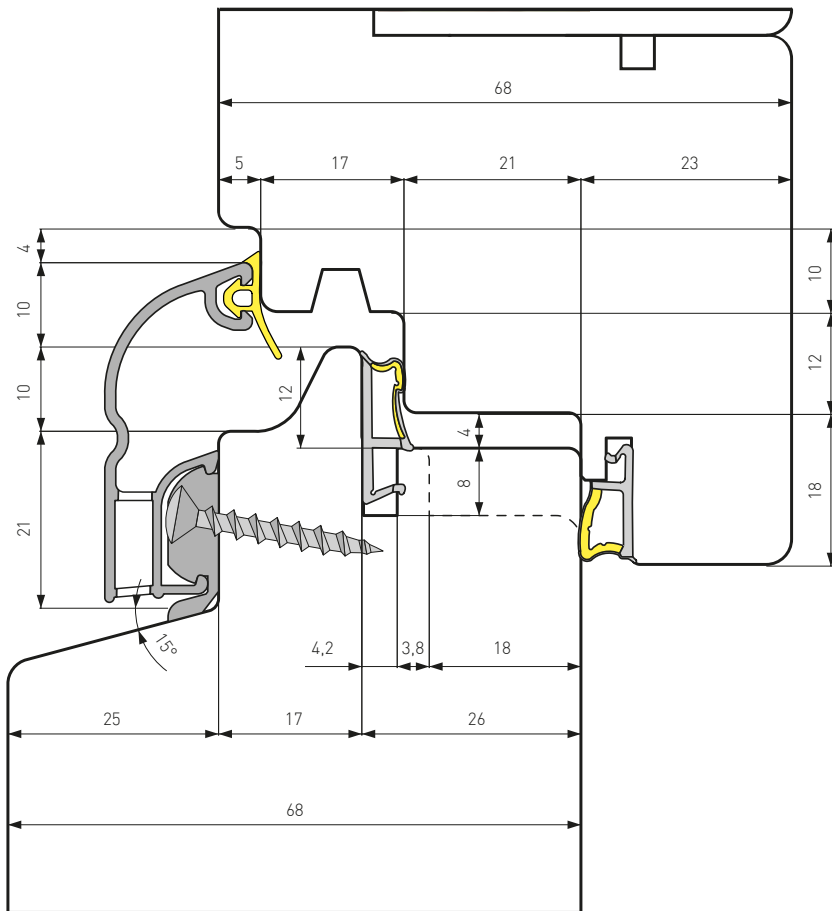

CASCADING FREUD

Ermetic 17
 Euronorm

ACCESSORI ACCESSORIES

terminale end cover	FP-334-010200	➤ p. 17
clip clip holder	FPA333A010200	➤ p. 55
guarnizione gasket	GA-9100030450	➤ p. 72
{	GC-5120040220	➤ p. 70
{	GD-5120030280	➤ p. 70
{	GC-6100030340	➤ p. 71
{	GD-6100030310	➤ p. 71

PRG334-010024	CODICE CODE	COLORE COLOUR	CF PK
	PRG334A010024	argento silver	24 ML
	PRG334B010024	bronzo chiaro light bronze	24 ML
	PRG334C010024	bronzo scuro dark bronze	24 ML
	PRG334F010024	RAL 9016 lucido gloss	24 ML
	PRG334H010024	bronzo medio middle bronze	24 ML

ACCESSORI PRG334
PRG334 ACCESSORIES

FP-333A010024	CLIP CLIP HOLDER		COLORE COLOUR	CF PK
	NYLON	FPA333A010200	neutro neutral	200 PZ

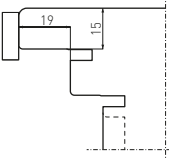
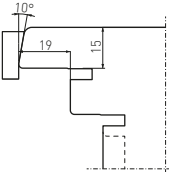
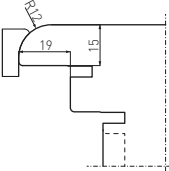
FP-334-010200	TERMINALE END COVER		COLORE COLOUR	CF PK
* 	TPE	FPB334A010200	bianco white	200 PZ
	TPE	FPN334A010200	marrone brown	200 PZ
* diritto right				
** 	TPE	FPB334B010200	bianco white	200 PZ
	TPE	FPN334B010200	marrone brown	200 PZ
** inclinato inclined				
*** 	TPE	FPB334C010200	bianco white	200 PZ
	TPE	FPN334C010200	marrone brown	200 PZ
*** morbido soft				

GA-9100030450	GUARNIZIONE GASKET		COLORE COLOUR	CF PK
	TP-S	GAB9100030450	bianco white	450 ML
	TP-S	GAG9100030450	grigio grey	450 ML
	TP-S	GAM9100030450	marrone brown	450 ML
	TP-S	GAN9100030450	nero black	450 ML

PRG335-010024

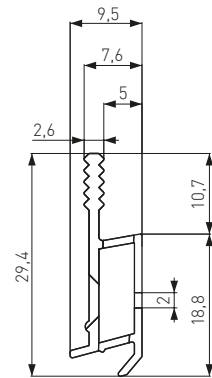
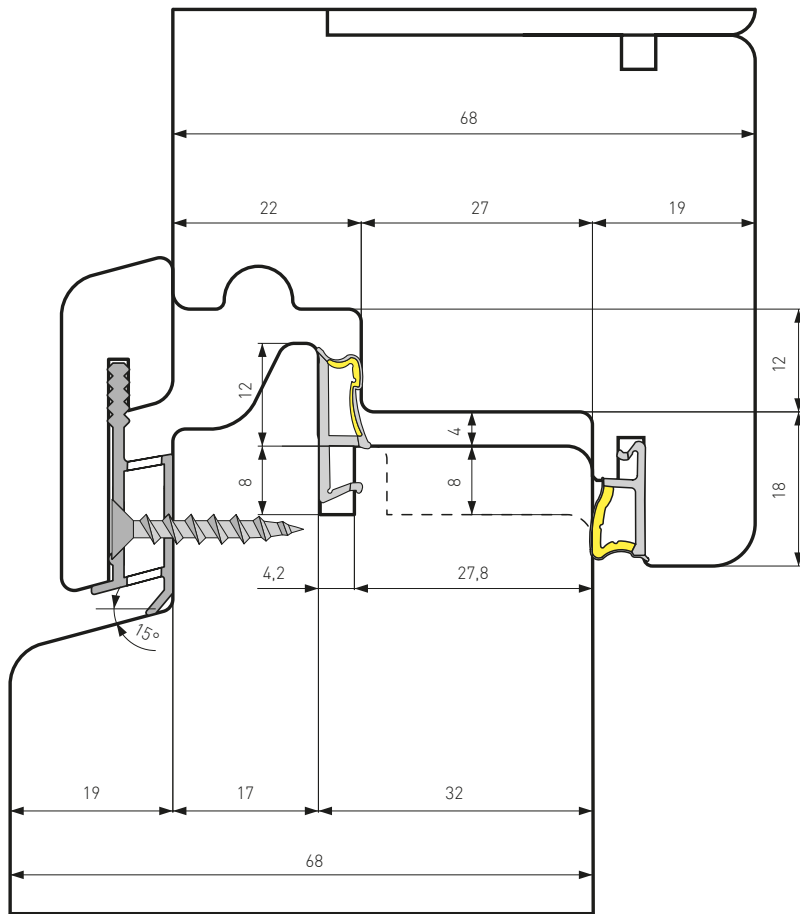

CASCADING FREUD

- Euronorm C-13
- Fox 92
- Freumex
- Freumex 17
- Freumex C-13



ACCESSORI ACCESSORIES

- guarnizione gasket | GC-5120040220 ↘ p. 70
- { GD-5120030280 ↘ p. 70
- { GC-6100030340 ↘ p. 71
- { GD-6100030310 ↘ p. 71

PRG335-010024	CODICE CODE	COLORE COLOUR	CF PK
	PRG335A010024	argento silver	24 ML

ACCESSORI PRG334
PRG334 ACCESSORIES

GA-9100030450		GUARNIZIONE GASKET	COLORE COLOUR	CF PK
	TP-S	GAB9100030450	bianco white	450 ML
	TP-S	GAG9100030450	grigio grey	450 ML
	TP-S	GAM9100030450	marrone brown	450 ML
	TP-S	GAN9100030450	nero black	450 ML

PRG367-010024

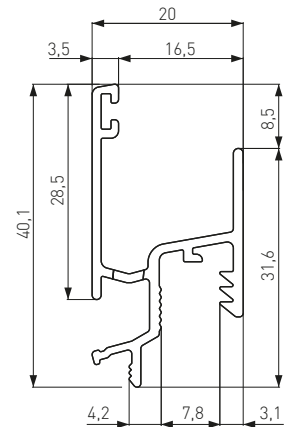
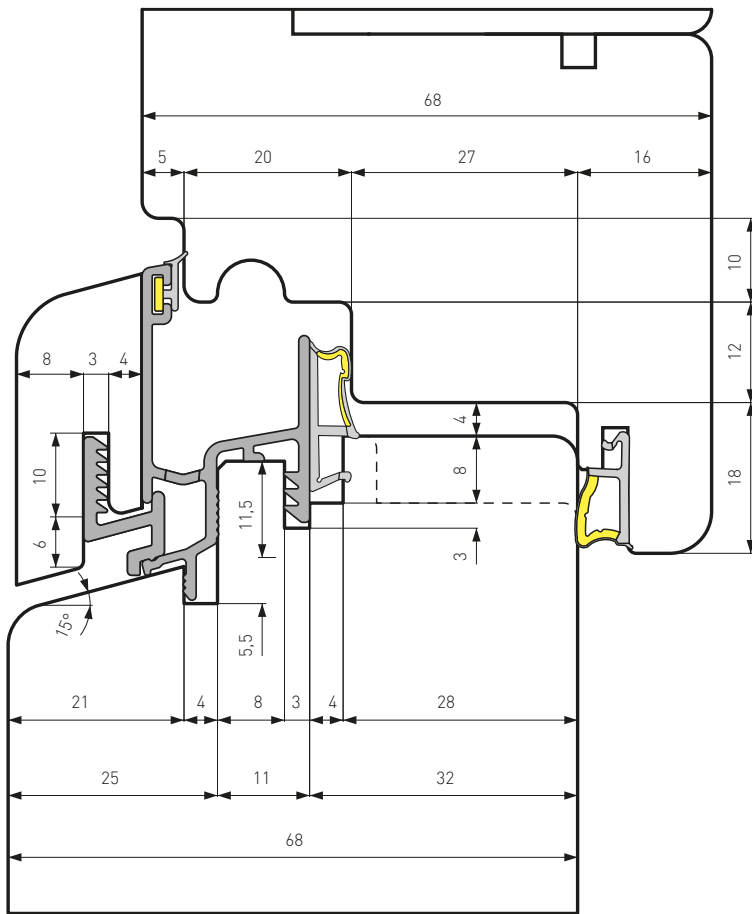

CASCADING FREUD

CE Euronorm C-13



ACCESSORI ACCESSORIES

terminale end cover	FP-367-010200	➤ p. 21
clip clip holder	FPA315A010200	➤ p. 54
guarnizione gasket	GA-8600020200	➤ p. 72
{	GC-5120040220	➤ p. 70
{	GD-5120030280	➤ p. 70
{	GC-6100030340	➤ p. 71
{	GD-6100030310	➤ p. 71

PRG367-010024	CODICE CODE	COLORE COLOUR	CF PK
	PRG367A010024	argento silver	24 ML
	PRG367B010024	bronzo chiaro light bronze	24 ML
	PRG367C010024	bronzo scuro dark bronze	24 ML
	PRG367F010024	RAL 9016 lucido gloss	24 ML
	PRG367H010024	bronzo medio middle bronze	24 ML
	PRG367S010024	RAL 9010 opaco matt	24 ML

ACCESSORI PRG367
PRG367 ACCESSORIES

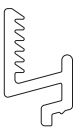
FPA315A010200	CLIP CLIP HOLDER		COLORE COLOUR	CF PK
	ALU	FPA315A010200	grezzo raw	200 PZ

FP-367-010200	TERMINALE END COVER		COLORE COLOUR	CF PK
* 	TPE	FPB367A010200	bianco white	200 PZ
	TPE	FPN367A010200	marrone brown	200 PZ
* spessore 68 mm thickness 68 mm				
** 	TPE	FPB367B010200	bianco white	200 PZ
	TPE	FPN367B010200	marrone brown	200 PZ
	** spessore 78 mm thickness 78 mm			

GA-8600020200	GUARNIZIONE GASKET		COLORE COLOUR	CF PK
	TP-S	GAB8600020200	bianco white	200 ML
	TP-S	GAM8600020200	marrone brown	200 ML
	TP-S	GAN8600020200	nero black	200 ML

SOGLEIE
THRESHOLDS



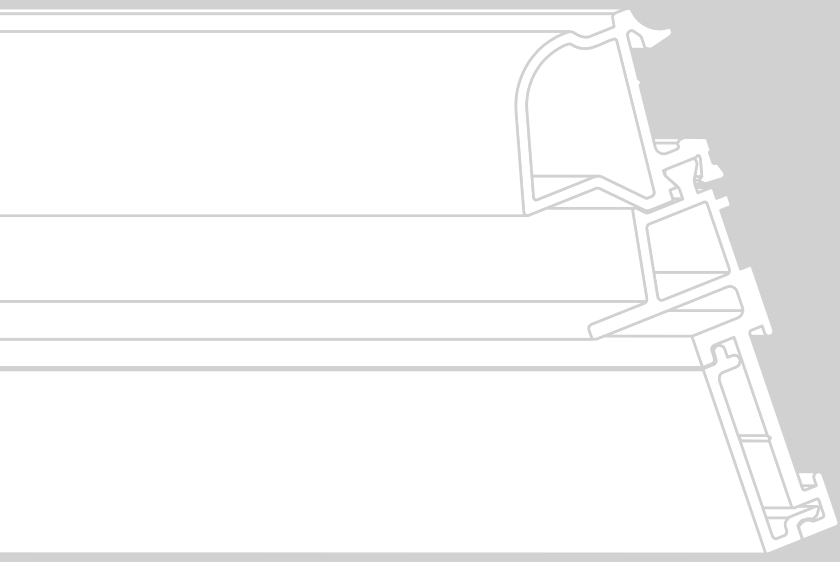

PRG024-010024

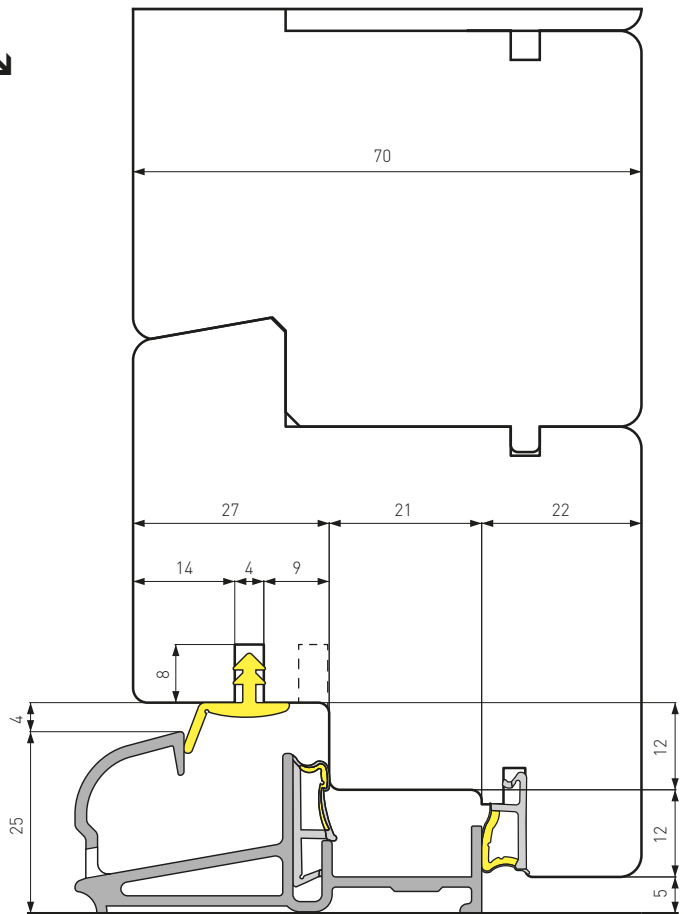
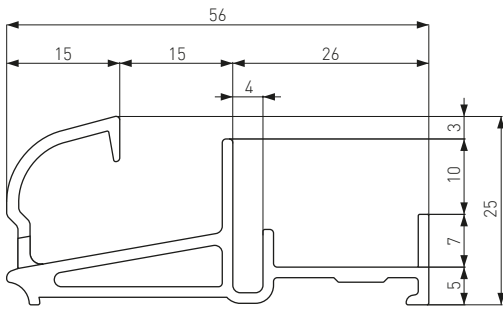

CASCADING FREUD

- CE Ermetic
- CE Ermetic 17
- CE Euronorm
- CE Eurost
- CE Eurost 17
- CE Freumex
- CE Freumex 17



ACCESSORI ACCESSORIES

- terminale end cover FPN024A010200 ↘ p. 25
- guarnizione gasket GA-9190020215 ↘ p. 72
- { GC-5120040220 ↘ p. 70
- { GD-5120030280 ↘ p. 70
- { GC-6100030340 ↘ p. 71
- { GD-6100030310 ↘ p. 71

PRG024-010024	CODICE CODE	COLORE COLOUR	CF PK
	PRG024A010024	argento silver	24 ML
	PRG024B010024	bronzo chiaro light bronze	24 ML
	PRG024C010024	bronzo scuro dark bronze	24 ML
	PRG024F010024	RAL 9016 lucido gloss	24 ML
	PRG024H010024	bronzo medio middle bronze	24 ML

ACCESSORI PRG024
PRG024 ACCESSORIES

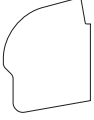
FPN024A010200		TERMINALE END COVER	COLORE COLOUR	CF PK
	TPP	FPN024A010200	neutro neutral	200 PZ

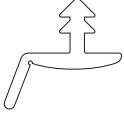
GA-9190020215		GUARNIZIONE GASKET	COLORE COLOUR	CF PK
	TP-S	GAB9190020215	bianco white	215 ML
	TP-S	GAM9190020215	marrone brown	215 ML
	TP-S	GAN9190020215	nero black	215 ML

PRG025-010024

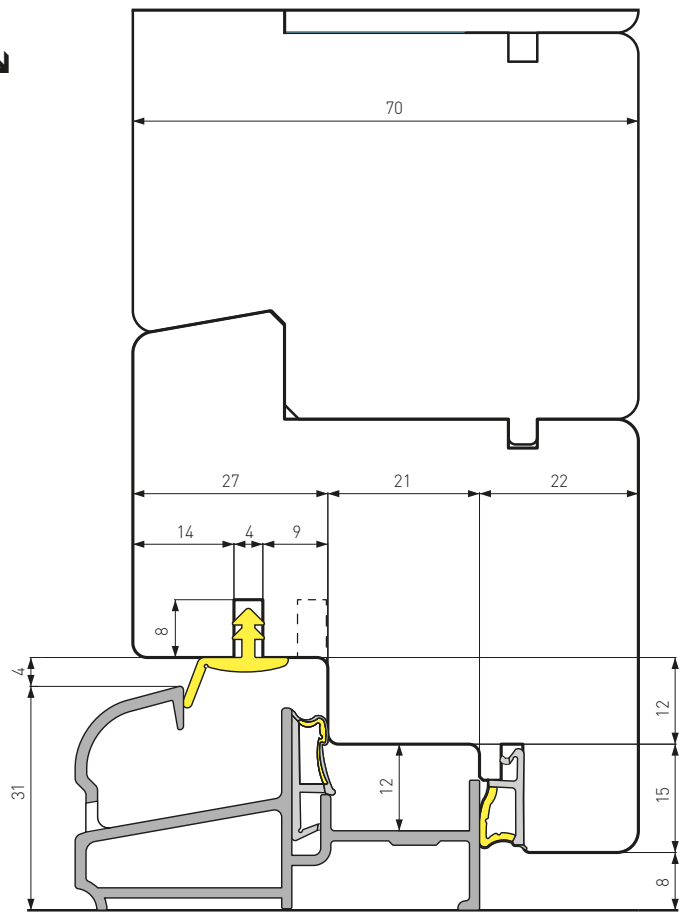
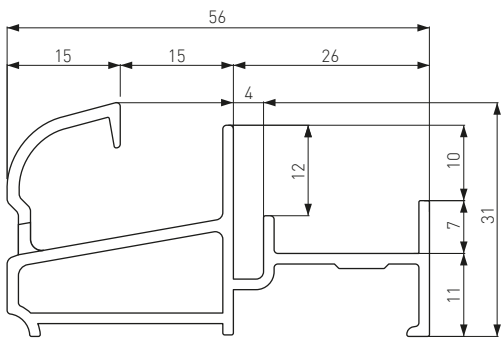

CASCADING FREUD

- CE Ermetic
- CE Ermetic 17
- CE Euronorm
- CE Eurost
- CE Eurost 17
- CE Freumex
- CE Freumex 17



ACCESSORI ACCESSORIES

- terminale end cover FPN024A010200 ↘ p. 27
- guarnizione gasket GA-9190020215 ↘ p. 71
- { GC-5120040220 ↘ p. 70
- { GD-5120030280 ↘ p. 70
- { GC-6100030340 ↘ p. 71
- { GD-6100030310 ↘ p. 71

PRG025-010024	CODICE CODE	COLORE COLOUR	CF PK
	PRG025A010024	argento silver	24 ML
	PRG025B010024	bronzo chiaro light bronze	24 ML
	PRG025C010024	bronzo scuro dark bronze	24 ML
	PRG025F010024	RAL 9016 lucido gloss	24 ML
	PRG025H010024	bronzo medio middle bronze	24 ML

ACCESSORI PRG025
PRG025 ACCESSORIES

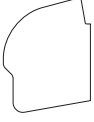
FPN024A010200		TERMINALE END COVER	COLORE COLOUR	CF PK
	TPP	FPN024A010200	neutro neutral	200 PZ

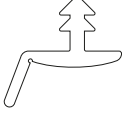
GA-9190020215		GUARNIZIONE GASKET	COLORE COLOUR	CF PK
	TP-S	GAB9190020215	bianco white	215 ML
	TP-S	GAM9190020215	marrone brown	215 ML
	TP-S	GAN9190020215	nero black	215 ML

PRG290-010024

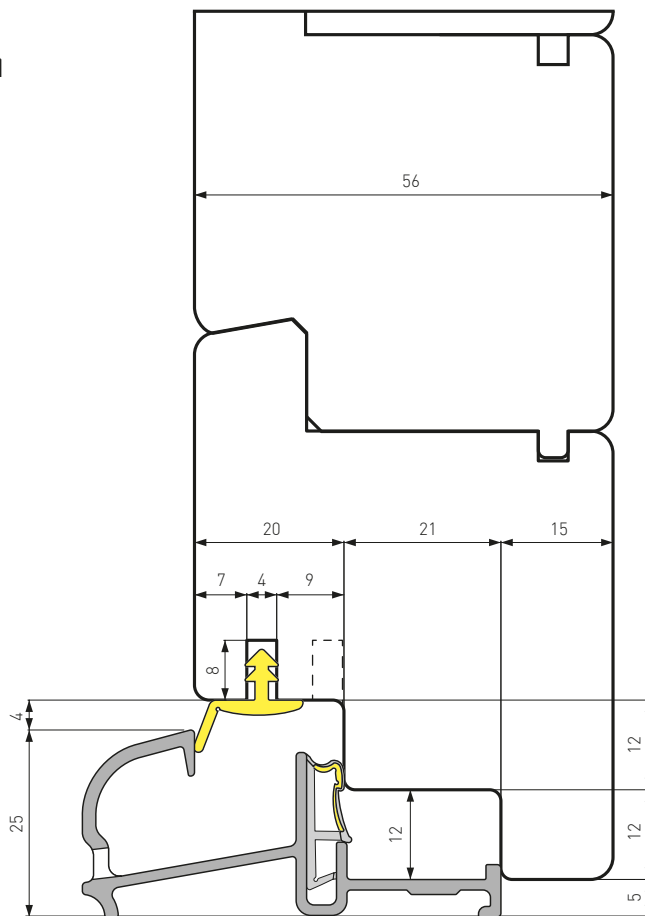
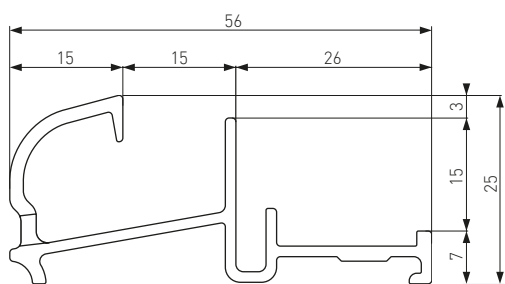

CASCADING FREUD

- CE Ermetic
- CE Ermetic 17
- CE Euronorm
- CE Eurost
- CE Eurost 17
- CE Freumex
- CE Freumex 17



ACCESSORI ACCESSORIES

- terminale end cover FPN289A010200 p. 29
- guarnizione gasket GA-9190020215 p. 72
- { GC-5120040220 p. 70
- { GD-5120030280 p. 70

PRG290-010024	CODICE CODE	COLORE COLOUR	CF PK
	PRG290A010024	argento silver	24 ML
	PRG290B010024	bronzo chiaro light bronze	24 ML
	PRG290C010024	bronzo scuro dark bronze	24 ML
	PRG290F010024	RAL 9016 lucido gloss	24 ML
	PRG290H010024	bronzo medio middle bronze	24 ML

ACCESSORI PRG290
PRG290 ACCESSORIES

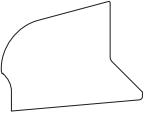
FPN289A010200		TERMINALE END COVER	COLORE COLOUR	CF PK
	TPP	FPN289A010200	neutro neutral	200 PZ

GA-9190020215		GUARNIZIONE GASKET	COLORE COLOUR	CF PK
	TP-S	GAB9190020215	bianco white	215 ML
	TP-S	GAM9190020215	marrone brown	215 ML
	TP-S	GAN9190020215	nero black	215 ML

PRG289-010024

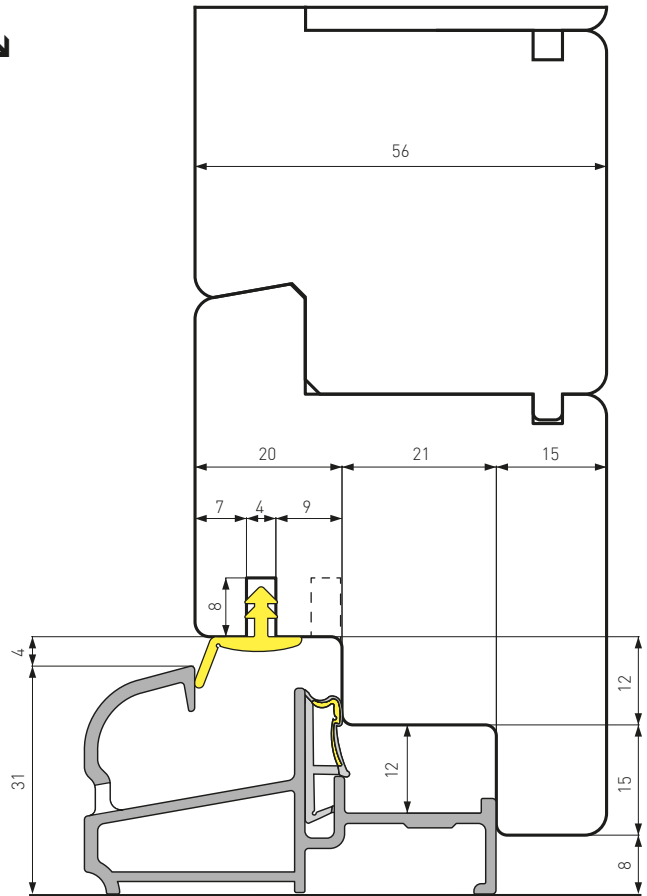
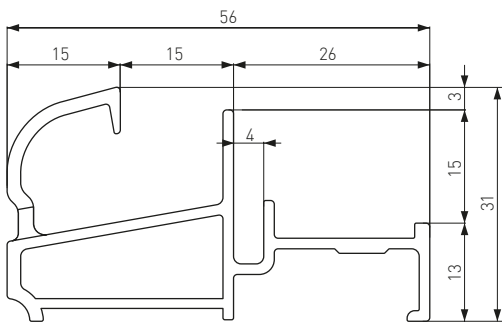

CASCADING FREUD

- CE Ermetic
- CE Ermetic 17
- CE Euronorm
- CE Eurost
- CE Eurost 17
- CE Freumex
- CE Freumex 17



ACCESSORI ACCESSORIES

- terminale end cover FPN289A010200 ↘ p. 31
- guarnizione gasket GA-9190020215 ↘ p. 72
- { GC-5120040220 ↘ p. 70
- { GD-5120030280 ↘ p. 70

PRG289-010024	CODICE CODE	COLORE COLOUR	CF PK
	PRG289A010024	argento silver	24 ML
	PRG289B010024	bronzo chiaro light bronze	24 ML
	PRG289C010024	bronzo scuro dark bronze	24 ML
	PRG289F010024	RAL 9016 lucido gloss	24 ML
	PRG289H010024	bronzo medio middle bronze	24 ML

ACCESSORI PRG289
PRG289 ACCESSORIES

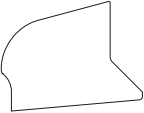
FPN289A010200		TERMINALE END COVER	COLORE COLOUR	CF PK
	TPP	FPN289A010200	neutro neutral	200 PZ

GA-9190020215		GUARNIZIONE GASKET	COLORE COLOUR	CF PK
	TP-S	GAB9190020215	bianco white	215 ML
	TP-S	GAM9190020215	marrone brown	215 ML
	TP-S	GAN9190020215	nero black	215 ML

PRG028-010024

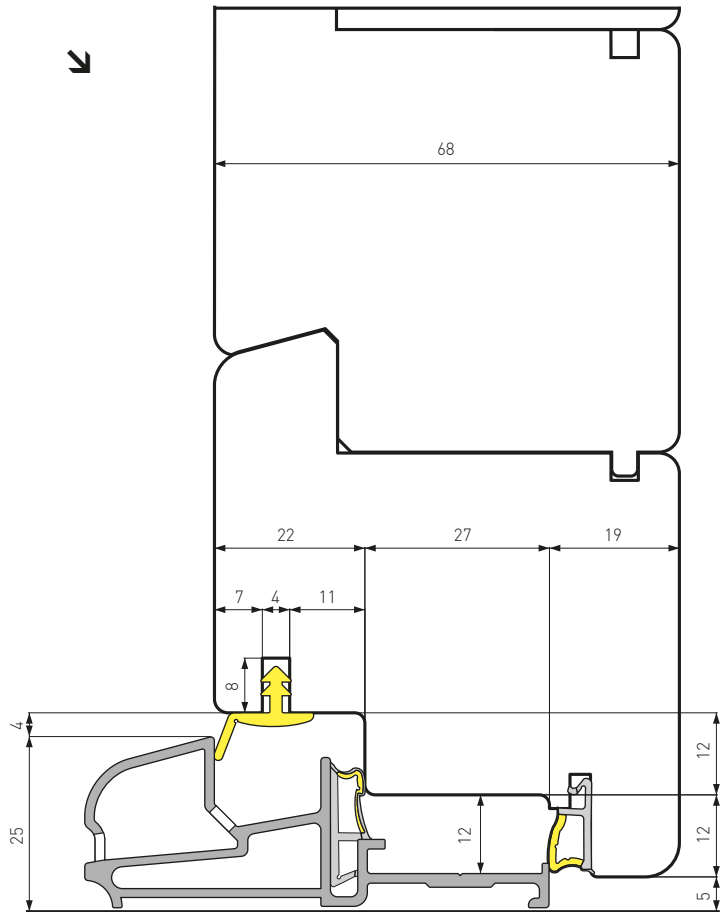
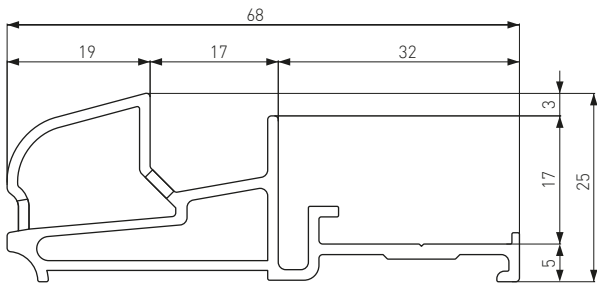

CASCADING FREUD

- CE Euronorm C-13
- CE Fox 92
- CE Freumex C-13
- CE Ghost
- CE Luce

ACCESSORI ACCESSORIES

- terminale end cover FPN028A010200 ↘ p. 33
- guarnizione gasket GA-9190020215 ↘ p. 72
- { GC-5120040220 ↘ p. 70
- { GD-5120030280 ↘ p. 70
- { GC-6100030340 ↘ p. 71
- { GD-6100030310 ↘ p. 71

PRG028-010024	CODICE CODE	COLORE COLOUR	CF PK
	PRG028A010024	argento silver	24 ML
	PRG028B010024	bronzo chiaro light bronze	24 ML
	PRG028C010024	bronzo scuro dark bronze	24 ML
	PRG028F010024	RAL 9016 lucido gloss	24 ML
	PRG028H010024	bronzo medio middle bronze	24 ML

ACCESSORI PRG289
PRG289 ACCESSORIES

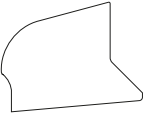
FPN028A010200		TERMINALE END COVER	COLORE COLOUR	CF PK
	TPP	FPN028A010200	neutro neutral	200 PZ

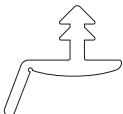
GA-9190020215		GUARNIZIONE GASKET	COLORE COLOUR	CF PK
	TP-S	GAB9190020215	bianco white	215 ML
	TP-S	GAM9190020215	marrone brown	215 ML
	TP-S	GAN9190020215	nero black	215 ML

PRG029-010024

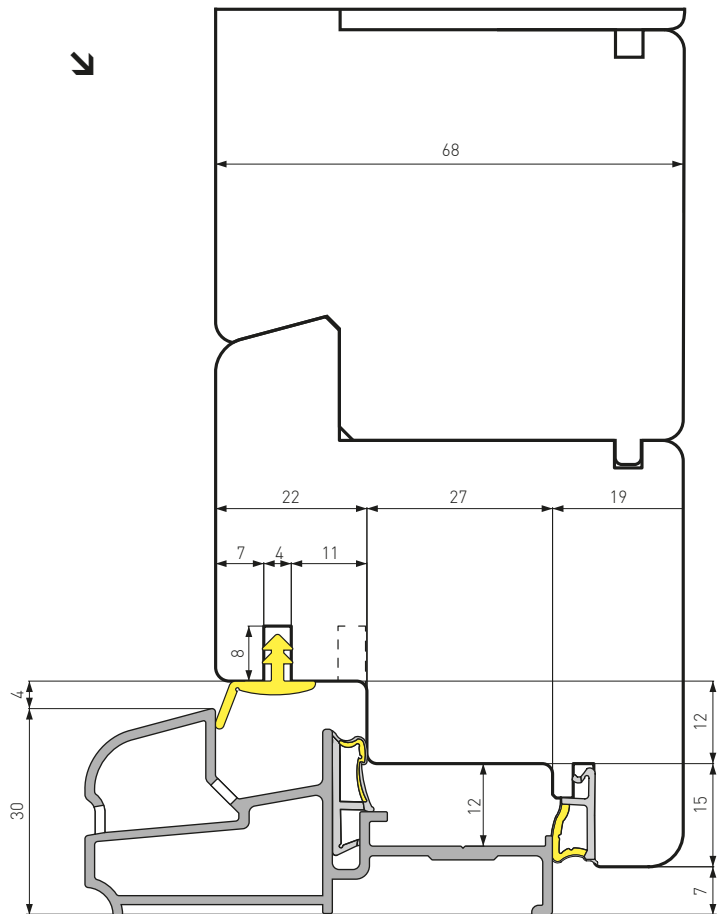
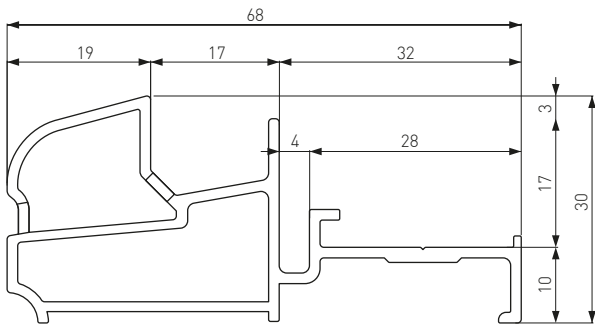

CASCADING FREUD

- CE Euronorm C-13
- CE Fox 92
- CE Freumex C-13
- CE Ghost
- CE Luce



ACCESSORI ACCESSORIES

- terminale end cover FPN028A010200 ↘ p. 35
- guarnizione gasket GA-9190020215 ↘ p. 72
- { GC-5120040220 ↘ p. 70
- { GD-5120030280 ↘ p. 70
- { GC-6100030340 ↘ p. 71
- { GD-6100030310 ↘ p. 71

PRG029-010024	CODICE CODE	COLORE COLOUR	CF PK
	PRG029A010024	argento silver	24 ML
	PRG029B010024	bronzo chiaro light bronze	24 ML
	PRG029C010024	bronzo scuro dark bronze	24 ML
	PRG029F010024	RAL 9016 lucido gloss	24 ML
	PRG029H010024	bronzo medio middle bronze	24 ML

ACCESSORI PRG029
PRG029 ACCESSORIES

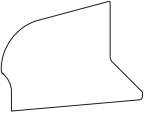
FPN028A010200		TERMINALE END COVER	COLORE COLOUR	CF PK
	TPP	FPN028A010200	neutro neutral	200 PZ

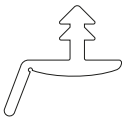
GA-9190020215		GUARNIZIONE GASKET	COLORE COLOUR	CF PK
	TP-S	GAB9190020215	bianco white	215 ML
	TP-S	GAM9190020215	marrone brown	215 ML
	TP-S	GAN9190020215	nero black	215 ML

PRT290-010024
SOGLIA A TAGLIO TERMICO
 THERMAL CUT THRESHOLD

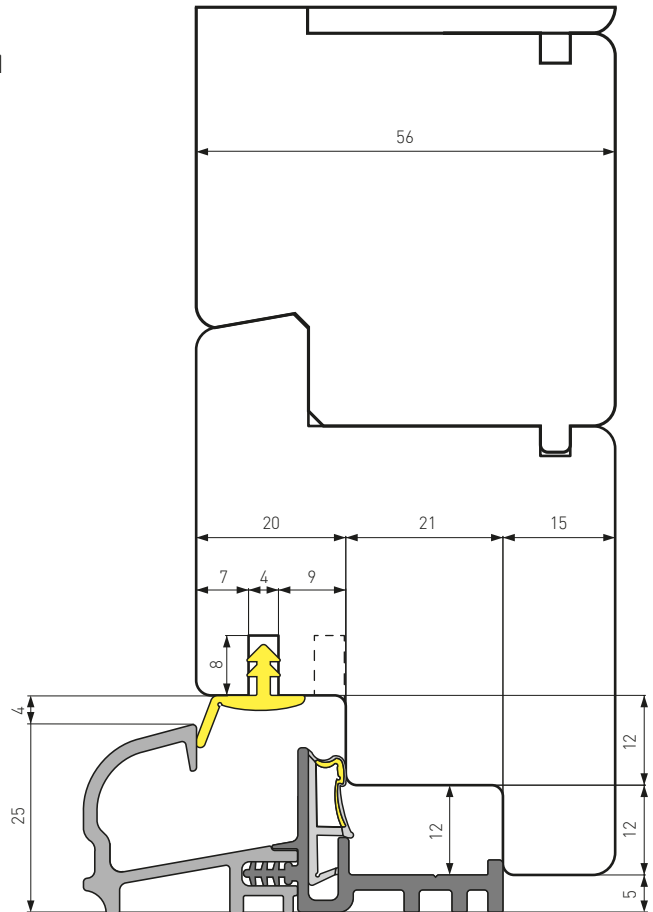
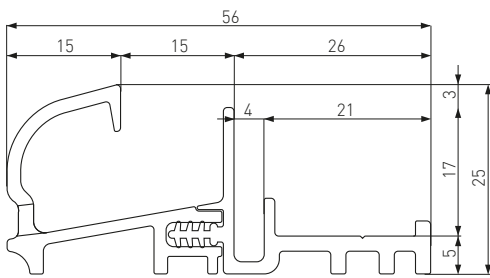

CASCADING FREUD

- CE Ermetic
- CE Ermetic 17
- CE Euronorm
- CE Eurost
- CE Eurost 17
- CE Freumex
- CE Freumex 17



ACCESSORI ACCESSORIES

- terminale end cover FPN289A010200 p. 37
- guarnizione gasket GA-9190020215 p. 72
- { GC-5120040220 p. 70
- { GD-5120030280 p. 70

PRT290-010024	CODICE CODE	COLORE COLOUR	CF PK
	PRT290A010024	argento silver	24 ML
	PRT290B010024	bronzo chiaro light bronze	24 ML
	PRT290C010024	bronzo scuro dark bronze	24 ML
	PRT290F010024	RAL 9016 lucido gloss	24 ML
	PRT290H010024	bronzo medio middle bronze	24 ML

ACCESSORI PRT290
PRT290 ACCESSORIES

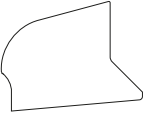
FPN289A010200		TERMINALE END COVER	COLORE COLOUR	CF PK
	TPP	FPN289A010200	neutro neutral	200 PZ

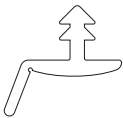
GA-9190020215		GUARNIZIONE GASKET	COLORE COLOUR	CF PK
	TP-S	GAB9190020215	bianco white	215 ML
	TP-S	GAM9190020215	marrone brown	215 ML
	TP-S	GAN9190020215	nero black	215 ML

PRT289-010024
SOGLIA A TAGLIO TERMICO
 THERMAL CUT THRESHOLD

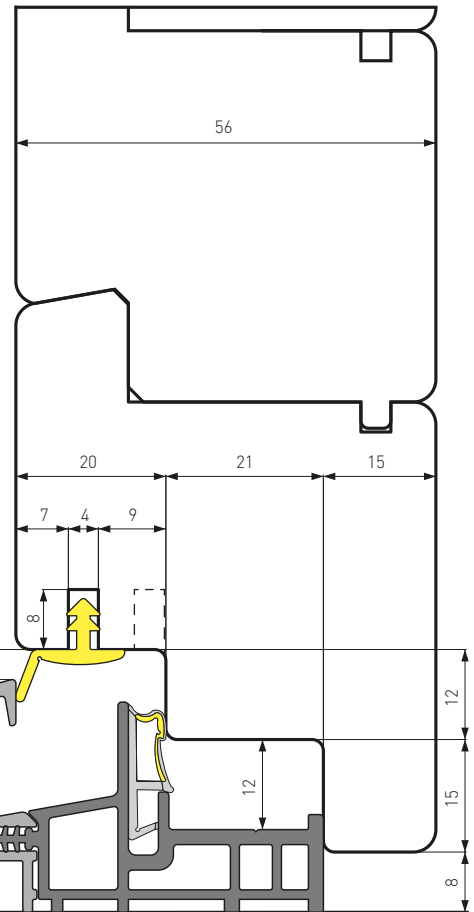
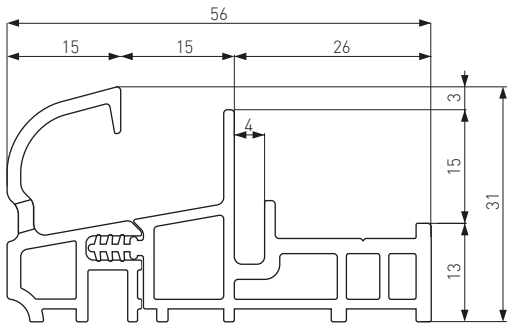

CASCADING FREUD

- CE Ermetic
- CE Ermetic 17
- CE Euronorm
- CE Eurost
- CE Eurost 17
- CE Freumex
- CE Freumex 17



ACCESSORI ACCESSORIES

- terminale end cover FPN289A010200 p. 39
- guarnizione gasket GA-9190020215 p. 72
- { GC-5120040220 p. 70
- { GD-5120030280 p. 70

PRT289-010024	CODICE CODE	COLORE COLOUR	CF PK
	PRT289A010024	argento silver	24 ML
	PRT289B010024	bronzo chiaro light bronze	24 ML
	PRT289C010024	bronzo scuro dark bronze	24 ML
	PRT289F010024	RAL 9016 lucido gloss	24 ML
	PRT289H010024	bronzo medio middle bronze	24 ML

ACCESSORI PRT289
PRT289 ACCESSORIES

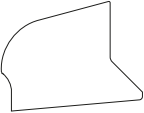
FPN289A010200		TERMINALE END COVER	COLORE COLOUR	CF PK
	TPP	FPN289A010200	neutro neutral	200 PZ

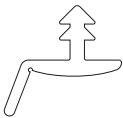
GA-9190020215		GUARNIZIONE GASKET	COLORE COLOUR	CF PK
	TP-S	GAB9190020215	bianco white	215 ML
	TP-S	GAM9190020215	marrone brown	215 ML
	TP-S	GAN9190020215	nero black	215 ML

PRT027-010024
SOGLIA A TAGLIO TERMICO
 THERMAL CUT THRESHOLD

NEW

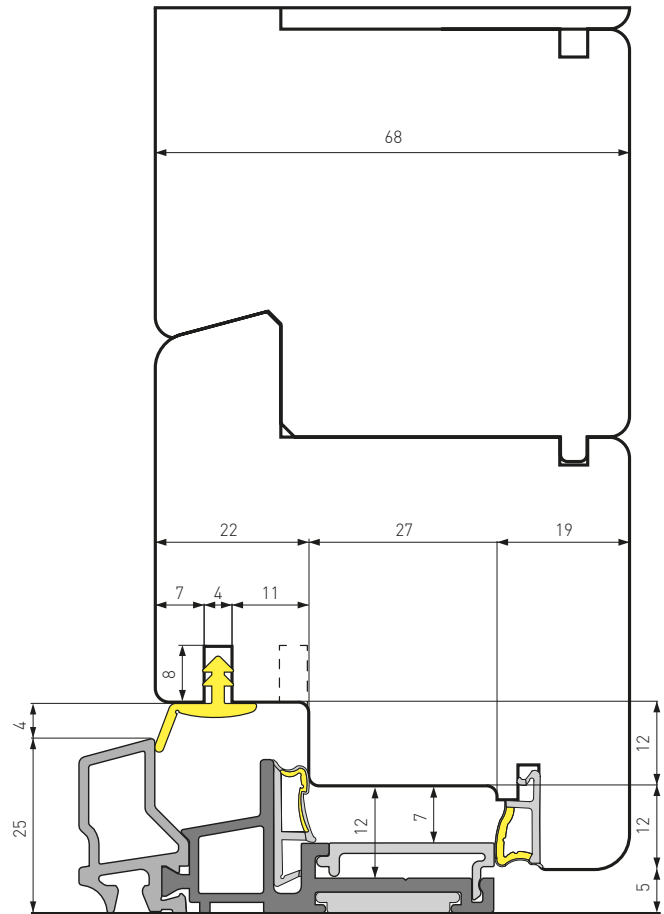
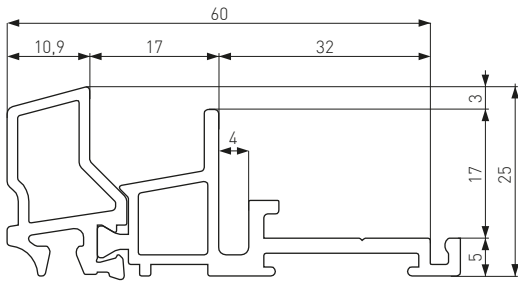

CASCADING FREUD

- CE Ghost
- CE Luce



ACCESSORI ACCESSORIES

- guarnizione gasket GA-9190020215 ↘ p. 72
- { GC-5120040220 ↘ p. 70
- { GD-5120030280 ↘ p. 70
- { GC-6100030340 ↘ p. 71
- { GD-6100030310 ↘ p. 71
- copertura cover PRT030-010024 ↘ p. 55
- piattina support PRT031X01002 ↘ p. 56

PRT027-010024	CODICE CODE	COLORE COLOUR	CF PK
	PRT027A010024	argento + ABS nero silver + black ABS	24 ML
	PRT027C010024	bronzo scuro + ABS nero dark bronze + black ABS	24 ML
	PRT027F010024	RAL 9016 lucido + ABS nero gloss + black ABS	24 ML
	PRT027G010024	argento + ABS grigio silver + grey ABS	

NEW**ACCESSORI PRT027**
PRT027 ACCESSORIES

PRT030-010024		COPERTURA COVER	COLORE COLOUR	CF PK
	ALU	PRT030A010024	argento silver	24 ML
	ALU	PRT030B010024	bronzo chiaro light bronze	24 ML
	ALU	PRT030C010024	bronzo scuro dark bronze	24 ML
	ALU	PRT030F010024	bianco white	24 ML
	ALU	PRT030H010024	bronzo medio middle bronze	24 ML

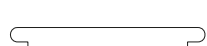
PRT031X010024		PIATTINA SUPPORT	COLORE COLOUR	CF PK
	ALU	PRT031X010024	grezzo raw	24 ML

NEW**SOGLIA + PIATTINA** THRESHOLD + SUPPORT

PRT027-010024-S	CODICE CODE	COLORE COLOUR	CF PK
soglia con piattina PRT031X010024 threshold with PRT031X010024 support	PRT027A010024-S	argento + ABS nero silver + black ABS	24 ML
	PRT027C010024-S	bronzo scuro + ABS nero dark bronze + black ABS	24 ML
	PRT027F010024-S	bianco + ABS nero white + black ABS	24 ML
	PRT027G010024-S	argento + ABS grigio silver + grey ABS	24 ML

PRT028-010024 *
SOGLIA A TAGLIO TERMICO
 THERMAL CUT THRESHOLD

*** FINO A ESAURIMENTO SCORTE**
 WHILE SUPPLIES LAST

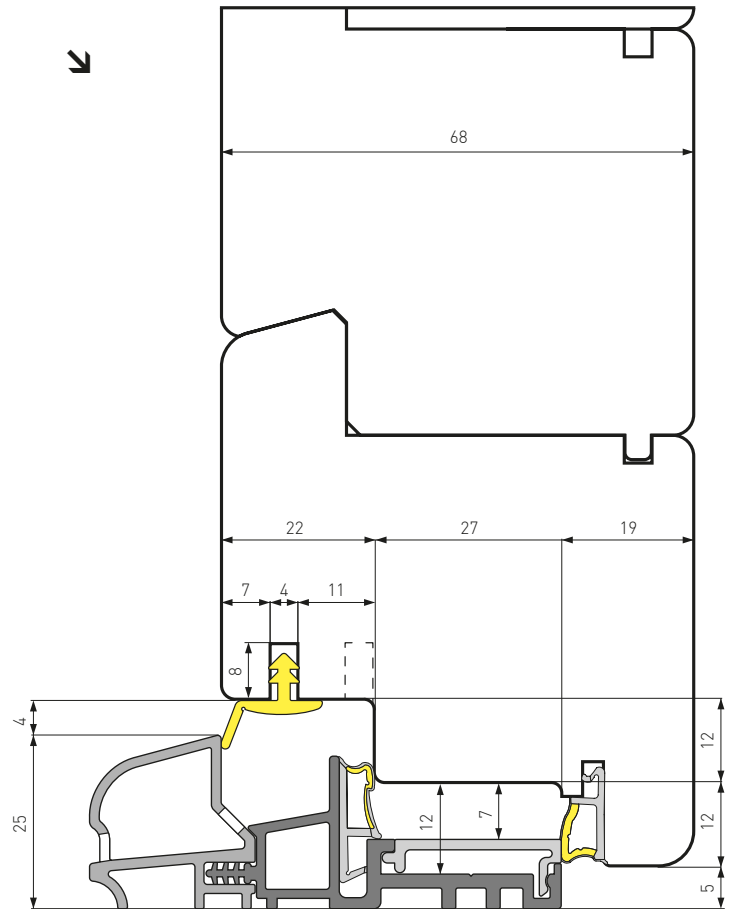
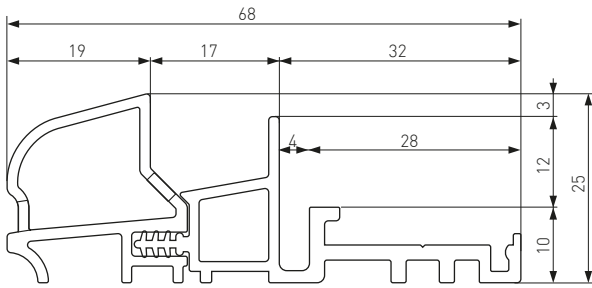

CASCADING FREUD

- Euronorm C-13
- Fox 92
- Freumex C-13



ACCESSORI ACCESSORIES

- terminale** end cover FPN028A010200 p. 43
- guarnizione** gasket GA-9190020215 p. 72
- { GC-5120040220 p. 70
- { GD-5120030280 p. 70
- { GC-6100030340 p. 71
- { GD-6100030310 p. 71
- copertura** covering PRT030-010024 p. 55

PRT028-010024	CODICE CODE	COLORE COLOUR	CF PK
	PRT028B010024	bronzo chiaro light bronze	24 ML
	PRT028C010024	bronzo scuro dark bronze	24 ML
	PRT028H010024	bronzo medio middle bronze	24 ML

ACCESSORI PRT028
PRT028 ACCESSORIES

PRT030-010024		COPERTURA COVER	COLORE COLOUR	CF PK
	ALU	PRT030A010024	argento silver	24 ML
	ALU	PRT030B010024	bronzo chiaro light bronze	24 ML
	ALU	PRT030C010024	bronzo scuro dark bronze	24 ML
	ALU	PRT030F010024	bianco white	24 ML
	ALU	PRT030H010024	bronzo medio middle bronze	24 ML

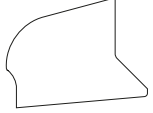
FPN028A010200		TERMINALE END COVER	COLORE COLOUR	CF PK
	TPP	FPN028A010200	neutro neutral	200 PZ

GA-9190020215		GUARNIZIONE GASKET	COLORE COLOUR	CF PK
	TP-S	GAB9190020215	bianco white	215 ML
	TP-S	GAM9190020215	marrone brown	215 ML
	TP-S	GAN9190020215	nero black	215 ML

PRT028-020024
SOGLIA A TAGLIO TERMICO
 THERMAL CUT THRESHOLD

NEW

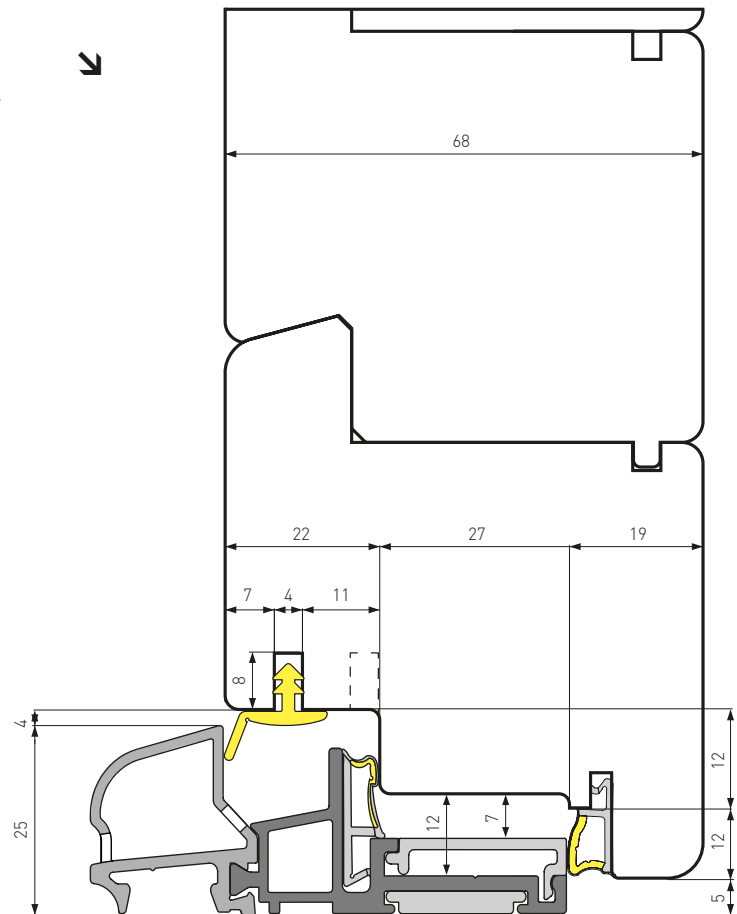
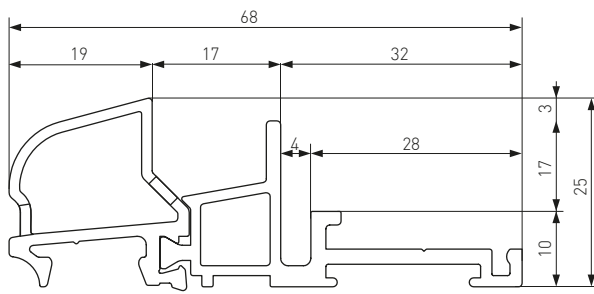

CASCADING FREUD

- CE Euronorm C-13
- CE Fox 92
- CE Freumex C-13
- CE Ghost
- CE Luce



ACCESSORI ACCESSORIES

- terminale end cover FPN028A010200 ↘ p. 45
- guarnizione gasket GA-9190020215 ↘ p. 72
- { GC-5120040220 ↘ p. 70
- { GD-5120030280 ↘ p. 70
- { GC-6100030340 ↘ p. 71
- { GD-6100030310 ↘ p. 71
- copertura cover PRT030-010024 ↘ p. 55
- piattina support PRT031X01002 ↘ p. 56

PRT028-020024	CODICE CODE	COLORE COLOUR	CF PK
	PRT028A020024	argento + ABS nero silver + black ABS	24 ML
	PRT028C020024	bronzo scuro + ABS nero dark bronze + black ABS	24 ML
	PRT028G020024	argento + ABS grigio silver + grey ABS	24 ML
	PRT028F020024	RAL 9016 lucido + ABS nero gloss + black ABS	

NEW**ACCESSORI PRT028**
PRT028 ACCESSORIES

PRT030-010024		COPERTURA COVER	COLORE COLOUR	CF PK
	ALU	PRT030A010024	argento silver	24 ML
	ALU	PRT030B010024	bronzo chiaro light bronze	24 ML
	ALU	PRT030C010024	bronzo scuro dark bronze	24 ML
	ALU	PRT030F010024	bianco white	24 ML
	ALU	PRT030H010024	bronzo medio middle bronze	24 ML

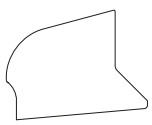
FPN028A010200		TERMINALE END COVER	COLORE COLOUR	CF PK
	TPP	FPN028A010200	neutro neutral	200 PZ

PRT031X010024		PIATTINA SUPPORT	COLORE COLOUR	CF PK
	ALU	PRT031X010024	grezzo raw	24 ML

NEW**SOGLIA + PIATTINA THRESHOLD + SUPPORT**

PRT028-020024-S	CODICE CODE	COLORE COLOUR	CF PK
soglia con piattina PRT031X010024 threshold with PRT031X010024 support	PRT028A020024-S	argento + ABS nero silver + black ABS	24 ML
	PRT028C020024-S	bronzo scuro + ABS nero dark bronze + black ABS	24 ML
	PRT028G020024-S	argento + ABS grigio silver + grey ABS	24 ML
	PRT028F020024-S	bianco + ABS nero white + black ABS	24 ML

PRT029-010024 *
SOGLIA A TAGLIO TERMICO
 THERMAL CUT THRESHOLD

*** FINO A ESAURIMENTO SCORTE**
 WHILE SUPPLIES LAST

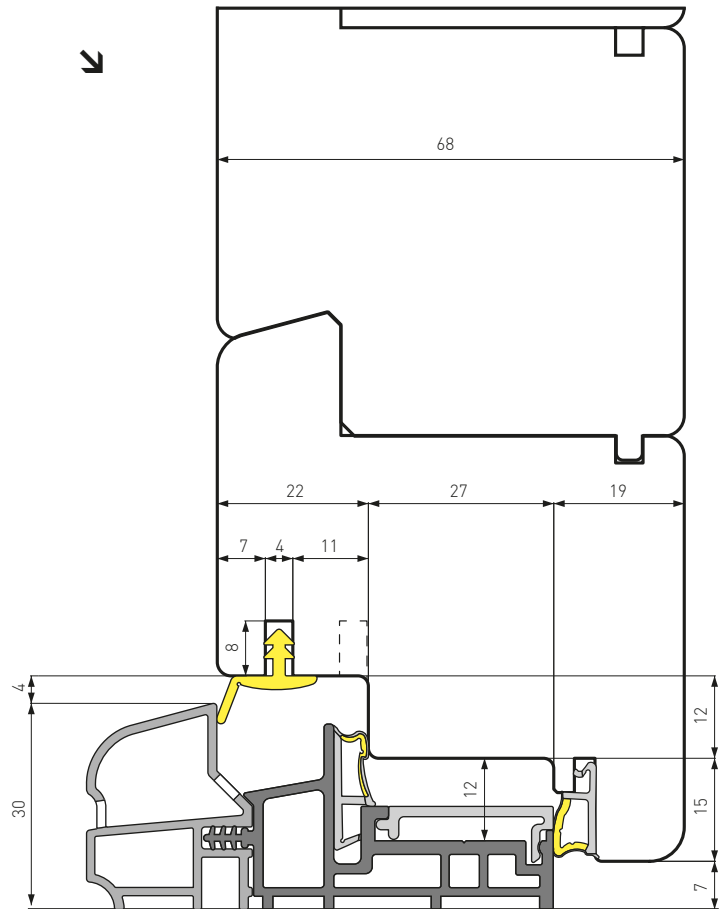
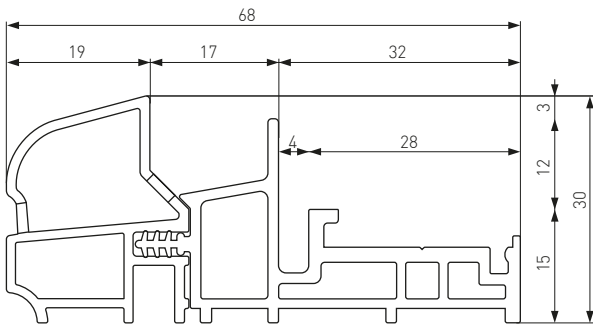

CASCADING FREUD

- CE Euronorm C-13
- CE Fox 92
- CE Freumex C-13

ACCESSORI ACCESSORIES

- terminale end cover FPN028A010200 ↘ p. 47
- guarnizione gasket GA-9190020215 ↘ p. 72
- { GC-5120040220 ↘ p. 70
- { GD-5120030280 ↘ p. 70
- { GC-6100030340 ↘ p. 71
- { GD-6100030310 ↘ p. 71
- copertura covering PRT030-010024 ↘ p. 55

PRT029-010024	CODICE CODE	COLORE COLOUR	CF PK
	PRT029A010024	argento silver	24 ML
	PRT029B010024	bronzo chiaro light bronze	24 ML
	PRT029C010024	bronzo scuro dark bronze	24 ML
	PRT029F010024	RAL 9016 lucido gloss	24 ML
	PRT029H010024	bronzo medio middle bronze	24 ML

ACCESSORI PRT028
PRT028 ACCESSORIES

PRT030-010024		COPERTURA COVER	COLORE COLOUR	CF PK
	ALU	PRT030A010024	argento silver	24 ML
	ALU	PRT030B010024	bronzo chiaro light bronze	24 ML
	ALU	PRT030C010024	bronzo scuro dark bronze	24 ML
	ALU	PRT030F010024	bianco white	24 ML
	ALU	PRT030H010024	bronzo medio middle bronze	24 ML

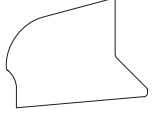
FPN028A010200		TERMINALE END COVER	COLORE COLOUR	CF PK
	TPP	FPN028A010200	neutro neutral	200 PZ

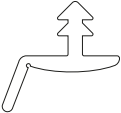
GA-9190020215		GUARNIZIONE GASKET	COLORE COLOUR	CF PK
	TP-S	GAB9190020215	bianco white	215 ML
	TP-S	GAM9190020215	marrone brown	215 ML
	TP-S	GAN9190020215	nero black	215 ML

PRT029-020024
SOGLIA A TAGLIO TERMICO
 THERMAL CUT THRESHOLD

NEW

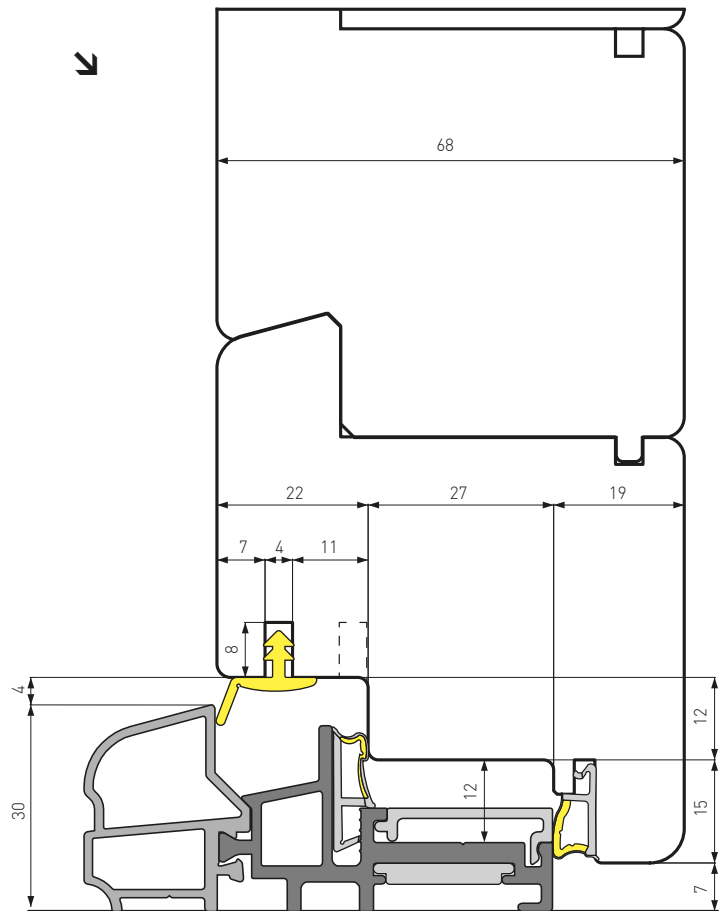
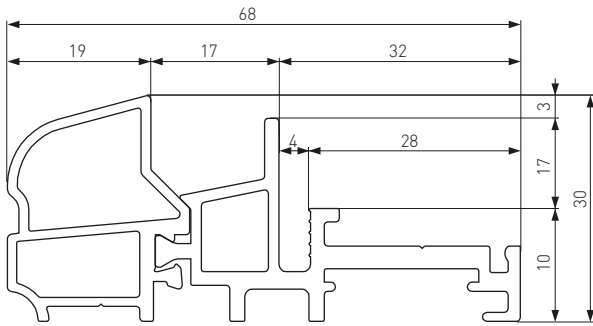

CASCADING FREUD

- CE Euronorm C-13
- CE Fox 92
- CE Freumex C-13
- CE Ghost
- CE Luce





ACCESSORI ACCESSORIES

- guarnizione gasket GA-9190020215 ↘ p. 72
- { GC-5120040220 ↘ p. 70
- { GD-5120030280 ↘ p. 70
- { GC-6100030340 ↘ p. 71
- { GD-6100030310 ↘ p. 71
- copertura cover PRT030-010024 ↘ p. 55
- piattina support PRT031X01002 ↘ p. 56
- piattina support PRT032X01002 ↘ p. 56

PRT029-020024	CODICE CODE	COLORE COLOUR	CF PK
	PRT029A020024	argento + ABS nero silver + black ABS	24 ML
	PRT029C020024	bronzo scuro + ABS nero dark bronze + black ABS	24 ML
	PRT029G020024	argento + ABS grigio silver + grey ABS	24 ML
	PRT029F020024	RAL 9016 lucido + ABS nero gloss + black ABS	24 ML

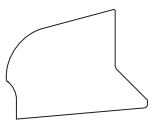
PRT030-010024		COPERTURA COVER	COLORE COLOUR	CF PK
	ALU	PRT030A010024	argento silver	24 ML
	ALU	PRT030B010024	bronzo chiaro light bronze	24 ML
	ALU	PRT030C010024	bronzo scuro dark bronze	24 ML
	ALU	PRT030F010024	bianco white	24 ML
	ALU	PRT030H010024	bronzo medio middle bronze	24 ML

FPN028A010200		TERMINALE END COVER	COLORE COLOUR	CF PK
	TPP	FPN028A010200	neutro neutral	200 PZ

PRT031X010024		PIATTINA SUPPORT	COLORE COLOUR	CF PK
	ALU	PRT031X010024	grezzo raw	24 ML

PRT032X010024		PRT032X010025	COLORE COLOUR	CF PK
	ALU	PRT032X010024	grezzo raw	24 ML
	ALU	PRT032X010025	grezzo raw	25 PZ x 23,5 CM
	piattina opzionale per cerniera a scomparsa optional support for hidden hinges			

SOGLIA + PIATTINA THRESHOLD + SUPPORT



PRT029-020024-S	CODICE CODE	COLORE COLOUR	CF PK
soglia con piattina PRT031X010024 threshold with PRT031X010024 support	PRT029A020024-S	argento + ABS nero silver + black ABS	24 ML
	PRT029G020024-S	argento + ABS grigio silver + grey ABS	24 ML
	PRT029F020024-S	bianco + ABS nero white + black ABS	24 ML

PRT038-010024
SOGLIA A TAGLIO TERMICO
 THERMAL CUT THRESHOLD

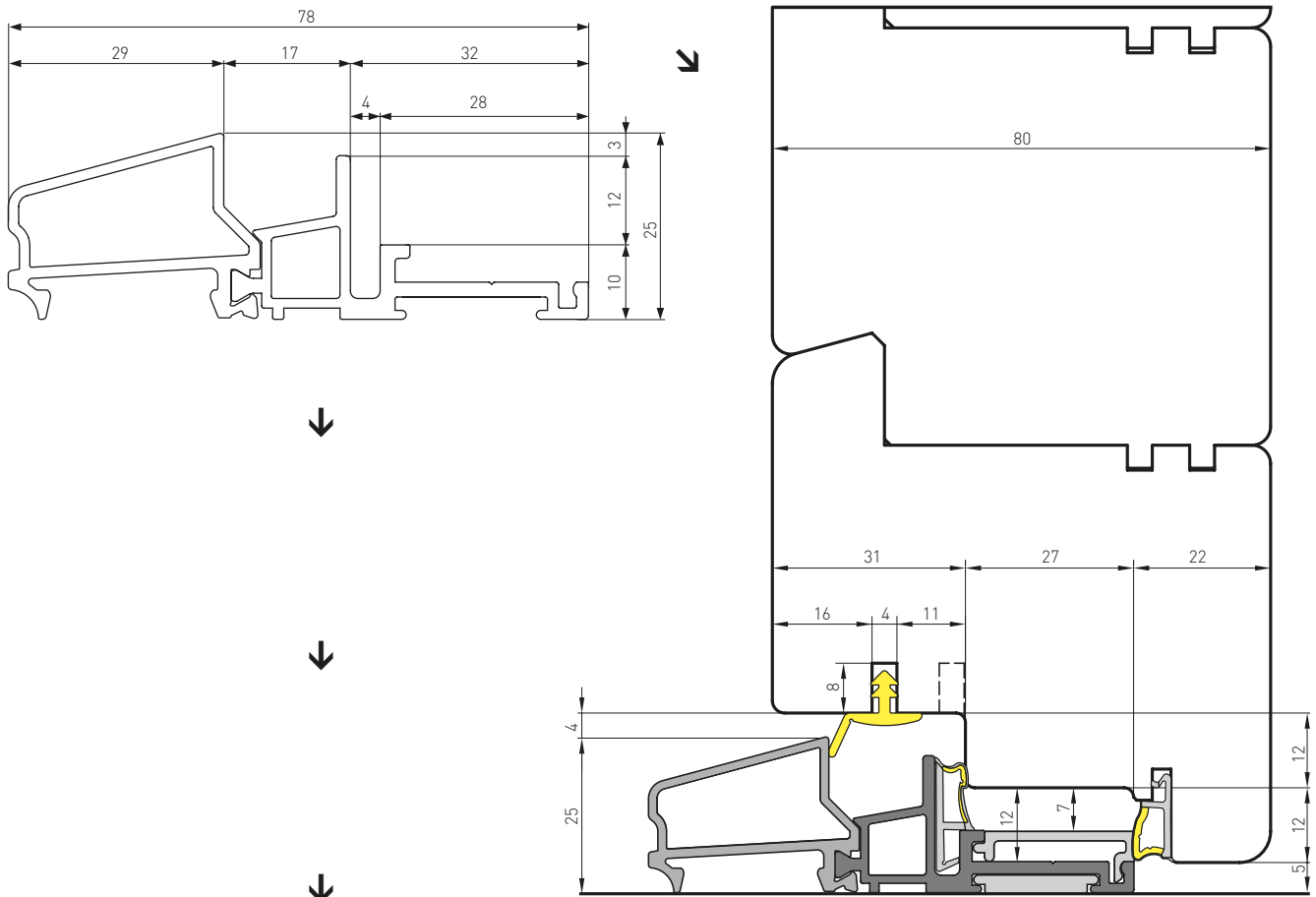
NEW









CASCADING FREUD

-  Euronorm C-13
-  Fox 92
-  Freumex C-13



ACCESSORI ACCESSORIES

- guarnizione gasket GA-9190020215  p. 72
- { GC-5120040220  p. 70
- { GD-5120030280  p. 70
- { GC-6100030340  p. 71
- { GD-6100030310  p. 71
- copertura cover PRT030-010024  p. 55
- piattina support PRT031X01002  p. 56

PRT038-010024	CODICE CODE	COLORE COLOUR	CF PK
	PRT038A010024	argento + ABS nero silver + black ABS	24 ML
	PRT038G010024	argento + ABS grigio silver + grey ABS	24 ML

NEW**ACCESSORI PRT038**
PRT038 ACCESSORIES

PRT030-010024	COPERTURA COVER		COLORE COLOUR	CF PK
	ALU	PRT030A010024	argento silver	24 ML
	ALU	PRT030B010024	bronzo chiaro light bronze	24 ML
	ALU	PRT030C010024	bronzo scuro dark bronze	24 ML
	ALU	PRT030F010024	bianco white	24 ML
	ALU	PRT030H010024	bronzo medio middle bronze	24 ML

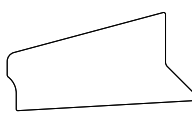
FPN038A010200	TERMINALE END COVER		COLORE COLOUR	CF PK
	TPP	FPN038A010200	neutro neutral	200 PZ

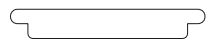
PRT031X010024	PIATTINA SUPPORT		COLORE COLOUR	CF PK
	ALU	PRT031X010024	grezzo raw	24 ML

NEW**SOGLIA + PIATTINA THRESHOLD + SUPPORT**

PRT038-010024-S	CODICE CODE	COLORE COLOUR	CF PK
soglia con piattina PRT031X010024 threshold with PRT031X010024 support	PRT038A010024-S	argento + ABS nero silver + black ABS	24 ML
	PRT038G010024-S	argento + ABS grigio silver + grey ABS	24 ML

PRT048-010024
SOGLIA A TAGLIO TERMICO
 THERMAL CUT THRESHOLD

NEW

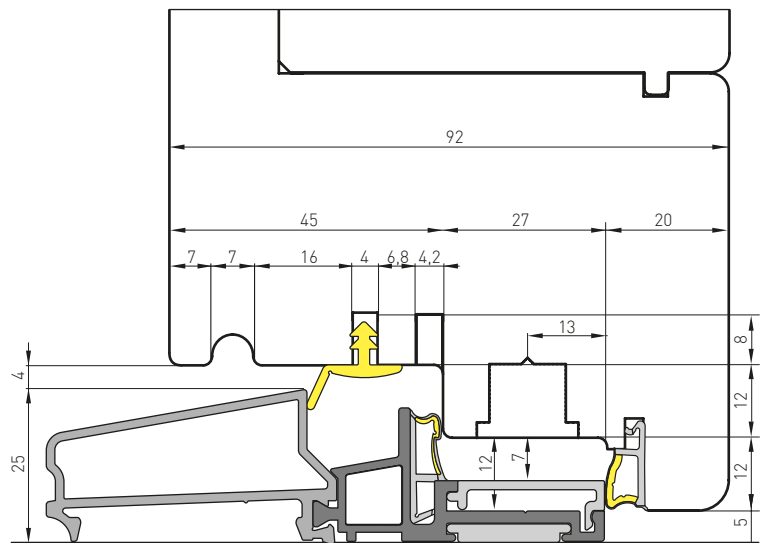
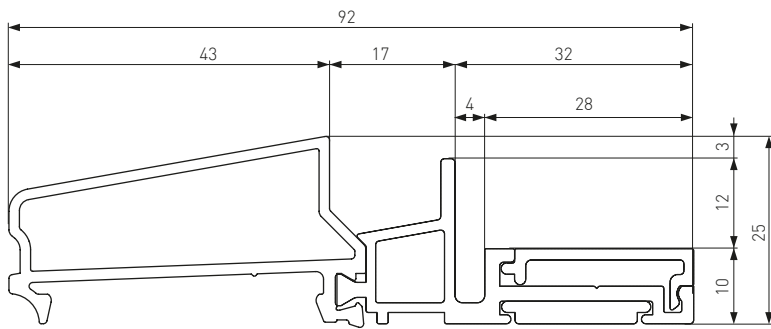

CASCADING FREUD

- CE Euronorm C-13
- CE Fox 92
- CE Freumex C-13





ACCESSORI ACCESSORIES

- guarnizione gasket GA-9190020215 ↘ p. 70
- { GC-5120040220 ↘ p. 68
- { GD-5120030280 ↘ p. 68
- { GC-6100030340 ↘ p. 69
- { GD-6100030310 ↘ p. 69
- copertura cover PRT030-010024 ↘ p. 53
- piattina support PRT031X01002 ↘ p. 54

PRT048-010024	CODICE CODE	COLORE COLOUR	CF PK
	PRT048A010024	argento + ABS nero silver + black ABS	24 ML
	PRT048G010024	argento + ABS grigio silver + grey ABS	24 ML

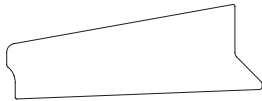
PRT030-010024		COPERTURA COVER	COLORE COLOUR	CF PK
	ALU	PRT030A010024	argento silver	24 ML
	ALU	PRT030B010024	bronzo chiaro light bronze	24 ML
	ALU	PRT030C010024	bronzo scuro dark bronze	24 ML
	ALU	PRT030F010024	bianco white	24 ML
	ALU	PRT030H010024	bronzo medio middle bronze	24 ML

FPN048A010200		TERMINALE END COVER	COLORE COLOUR	CF PK
	TPP	FPN048A010200	neutro neutral	200 PZ

PRT031X010024		PIATTINA SUPPORT	COLORE COLOUR	CF PK
	ALU	PRT031X010024	grezzo raw	24 ML

SOGLIA + PIATTINA THRESHOLD + SUPPORT

PRT048-010024-S	CODICE CODE	COLORE COLOUR	CF PK
soglia con piattina PRT031X010024 threshold with PRT031X010024 support	PRT048A010024-S	argento + ABS nero silver + black ABS	24 ML
	PRT048G010024-S	argento + ABS grigio silver + grey ABS	24 ML

ACCESSORI GOCCIOLATOI E SOGLIE
WEATHER BARS AND THRESHOLDS ACCESSORIES

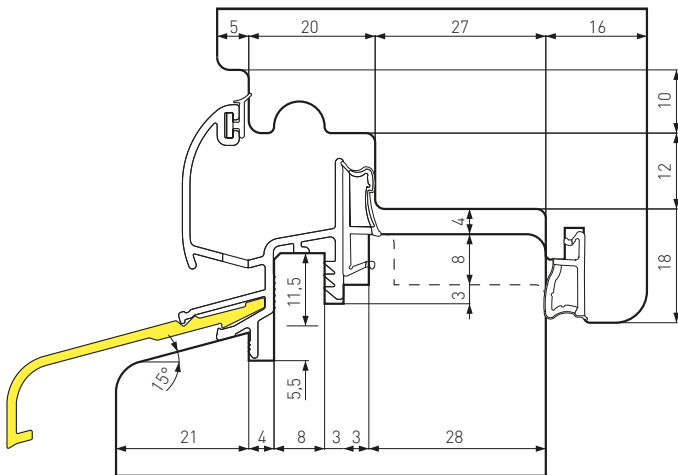

APPLICAZIONE A

APPLICATION TO

PRG311-010024
PRG312-010024
PRG313-010024
PRG314-010024
PRG317-010024
PRG318-010024
PRG367-010024

PRG323-010024	GRONDALINO WEATHER BAR SILL		COLORE COLOUR	CF PK
	ALU	PRG323A010024	argento silver	24 ML
	ALU	PRG323B010024	bronzo chiaro light bronze	24 ML
	ALU	PRG323C010024	bronzo scuro dark bronze	24 ML
	ALU	PRG323F010024	bianco white	24 ML
	ALU	PRG323H010024	bronzo medio middle bronze	24 ML

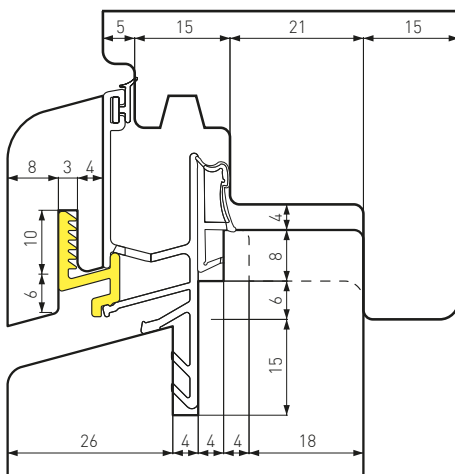

APPLICAZIONE A

APPLICATION TO

PRG311-010024
PRG313-010024
PRG317-010024
PRG367-010024

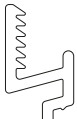
FPA315A010200	CLIP CLIP HOLDER		COLORE COLOUR	CF PK
	ALU	FPA315A010200	grezzo raw	200 PZ

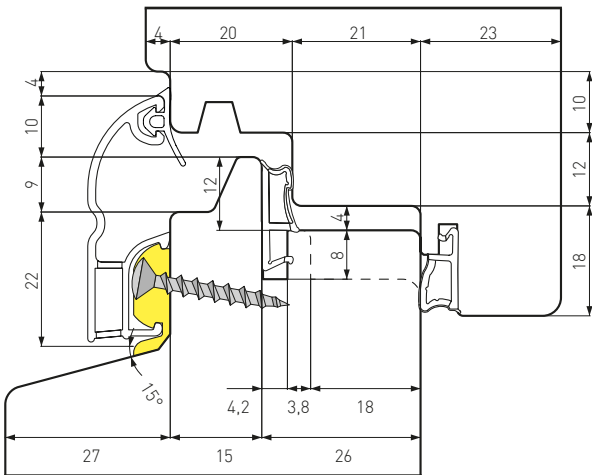

APPLICAZIONE A
 APPLICATION TO
 PRG333-010024
 PRG334-010024

FP-333A010024		CLIP CLIP HOLDER	COLORE COLOUR	CF PK
	NYLON	FPA333A010200	neutro neutral	200 PZ

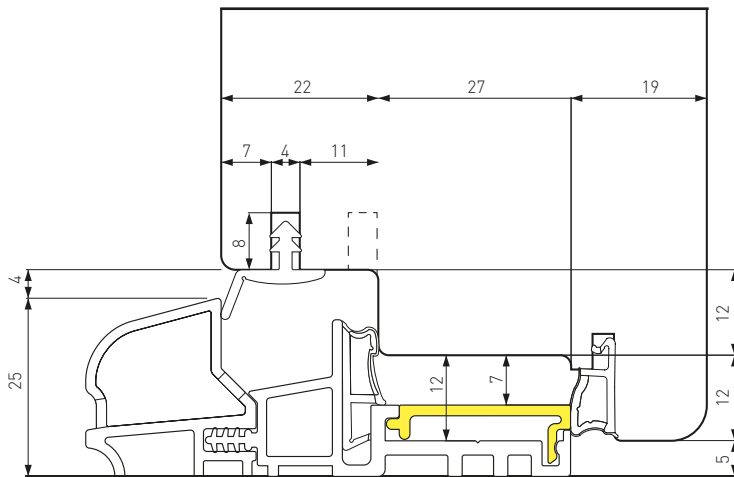

APPLICAZIONE A
 APPLICATION TO
 PRT027-010024
 PRT028-010024
 PRT028-020024
 PRT029-010024
 PRT029-020024
 PRT038-010024
 PRT048-010024

PRT030-010024		COPERTURA COVER	COLORE COLOUR	CF PK
	ALU	PRT030A010024	argento silver	24 ML
	ALU	PRT030B010024	bronzo chiaro light bronze	24 ML
	ALU	PRT030C010024	bronzo scuro dark bronze	24 ML
	ALU	PRT030F010024	bianco white	24 ML
	ALU	PRT030H010024	bronzo medio middle bronze	24 ML

PIATTINE
SUPPORTS

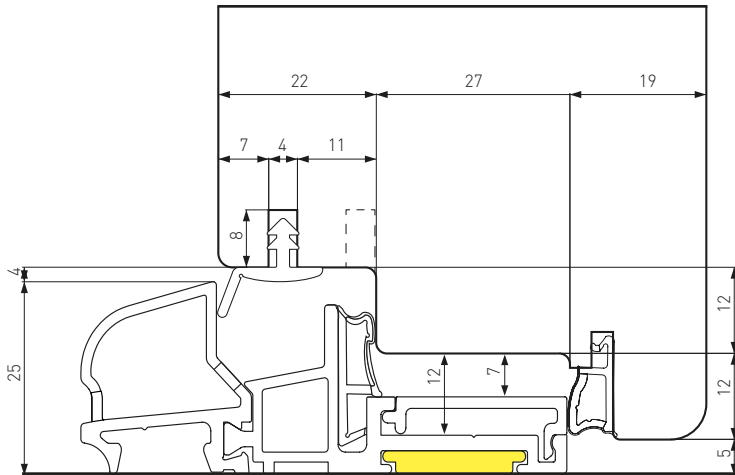

APPLICAZIONE A

APPLICATION TO

PRT027-010024

PRT028-020024

PRT029-020024

PRT038-010024

PRT048-010024

PRT031X010024		COLORE COLOUR		CF PK
	ALU	PRT031X010024	grezzo raw	24 ML

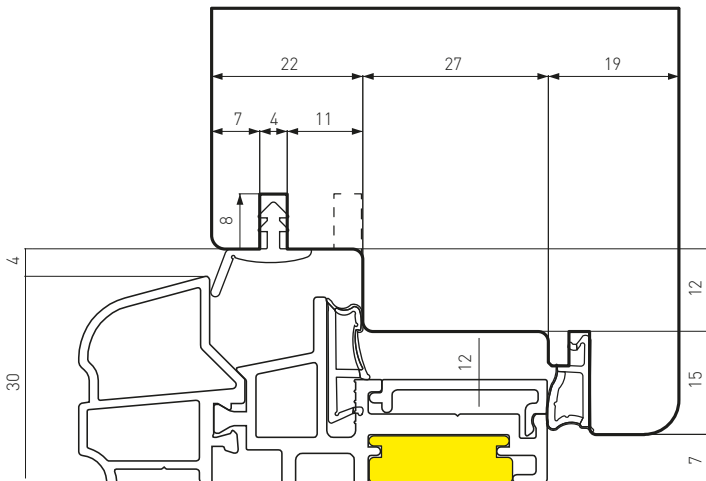

APPLICAZIONE A

APPLICATION TO

PRT029-020024



piattina opzionale
per cerniera
a scomparsa
optional support
for hidden hinges

PRT032X010024		PRT032X010025		COLORE COLOUR		CF PK
	ALU	PRT032X010024	grezzo raw	24 ML		
	ALU	PRT032X010024	grezzo raw	25 PZ x 23,5 CM		

PROFILI FERMAVETRO
GLASS PROFILES

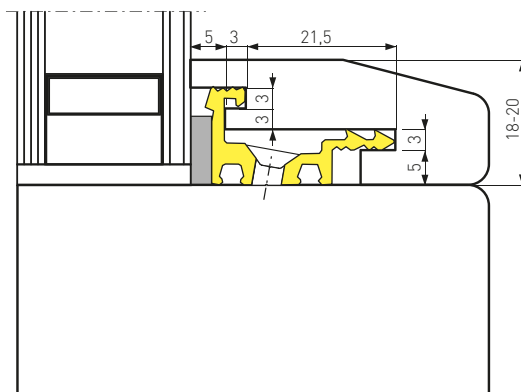
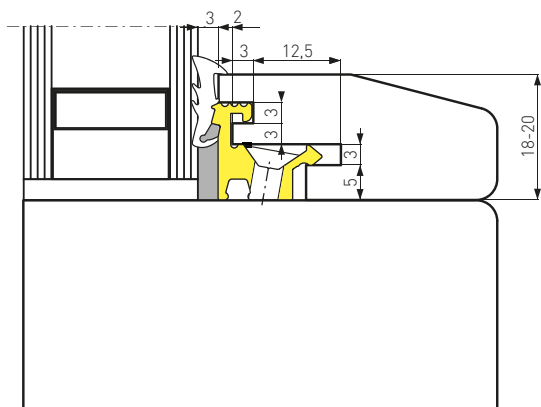

PFV1614010024		COLORE COLOUR	CF PK
	ALU	PFV1614010024	grezzo raw

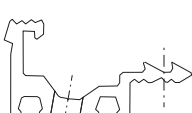
PFV2714010024		COLORE COLOUR	CF PK
	ALU	PFV2714010024	grezzo raw

GAT3000010300		COLORE COLOUR	CF PK
	TPE	GAT3000010300	trasparente transparent

PAMUSS10	GUARNIZIONE ADESIVA ESPANSA ADHESIVE EXPANDED GASKET	CF PK
	nastro in neoprene a cellule chiuse con supporto adesivo 10x5 mm	10 ML
	10x5 mm closed-cell neoprene tape with adhesive backing	

→  GA-3630010300 guarnizione fermavetro
GA-3630010300 glass gasket
↘ p. 80

G U T M

1 A N N

Le soglie GUTMANN soddisfano i requisiti predisposti dalla normativa DIN 18040 1 + 2, relativa alle costruzioni senza barriere architettoniche. Resistono all'acqua per livelli superiori a 1350 Pa, certificato IFT, con una guarnizione in gomma cellulare nella sezione della soglia.

GUTMANN thresholds are suitable for barrier-free building by DIN 18040 part 1 + 2.
Fulfilled highest watertightness up to 1350 Pa, IFT-certicated, with a cellular rubber gasket in the section of the threshold.

CARATTERISTICHE

FEATURES

Riduzione del punto di rugiada o della formazione della condensa attraverso un'ottima gestione isoterma.

Punti di fissaggio nascosti nella finestra con l'applicazione di una piattina di supporto.

Controlavorazione predisposta attraverso l'applicazione di tappi di testa.

Elementi di protezione intercambiabili e disponibili in alluminio e in plastica.

Materiali plastici privi di PVC.

Reduction of dew point performance or condensate formation via an optimal isothermal run.

Concealed screwing on the frame via application of the threshold support.

Counter-milling dispensed by using the filler pieces.

Exchangeable step protection optional plastic or aluminium.

Used plastic is PVC free.

LISTA DEGLI ARTICOLI GUTMANN DISPONIBILI

LIST OF AVAILABLE GUTMANN ITEMS

WESER TI con accessori;

WESER 20 TI con accessori;

soglia da interno INT P 60-15 con accessori;

MV 26.11 profilo di chiusura per alzante scorrevole con accessori;

grondalini FP 18 e FP 20 con clip e terminali.

WESER TI with accessories;

WESER 20 TI with accessories;

thresholds for interiors INT P 60-15 with accessories;

MV 26.11 locking profile for lifting sliding doors, with accessories;

weather bar sill FP 18 and FP 20 with clips and end covers.



GUTMANN

WESER TI E ACCESSORI
WESER TI AND ACCESSORIES

WESER 65 TI

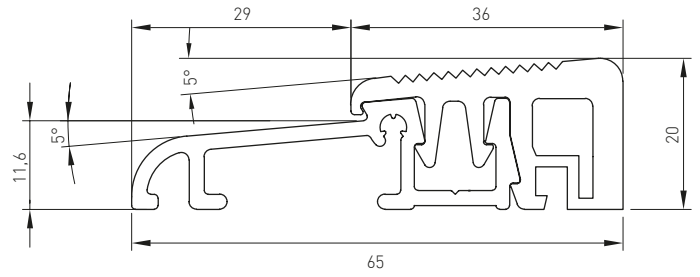

WESER 75 TI

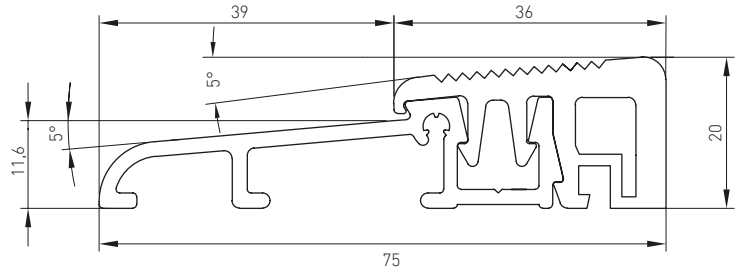

WESER 95 TI

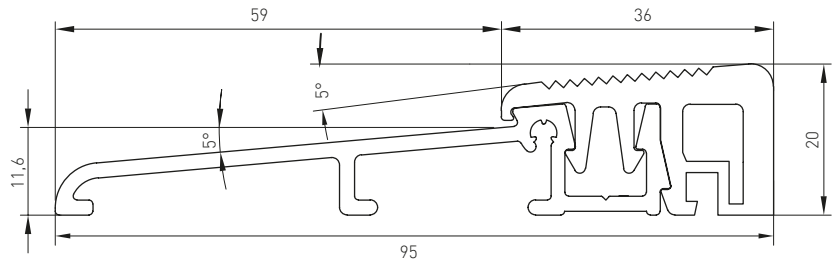

WESER TI		COLORE COLOUR	CF PK
	ALU + ABS	argento + ABS nero silver + black ABS	6 ML

TD 50	TERMINALE END COVER	COLORE COLOUR	CF PK
	EDPM	nero black	1 ML

SH Weser	PIATTINA SUPPORT	COLORE COLOUR	CF PK
	ABS	nero black	1 PZ

WESER 20 TI E ACCESSORI
WESER 20 TI AND ACCESSORIES

WESER 65/20 TI

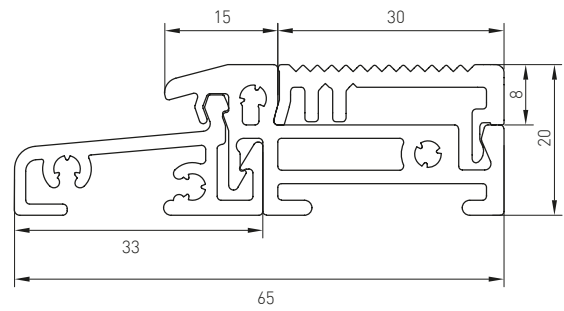

WESER 75/20 TI

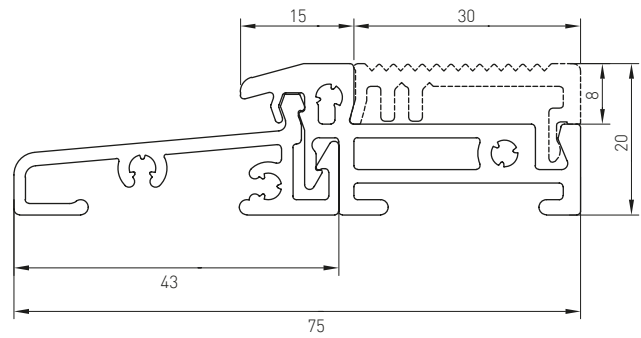

WESER 95/20 TI

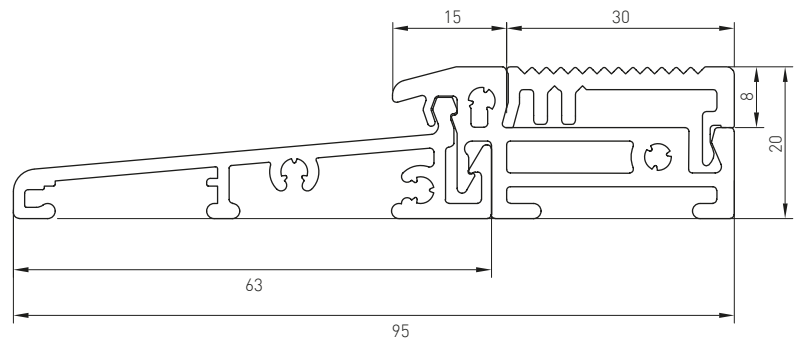

WESER 20 TI		COLORE COLOUR	CF PK
	ALU + ABS	argento + ABS nero silver + black ABS	6 ML

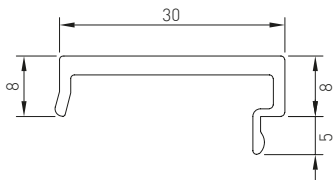
WESER D 8	COPERTURA COVER	COLORE COLOUR	CF PK
	ALU	argento silver	6 ML

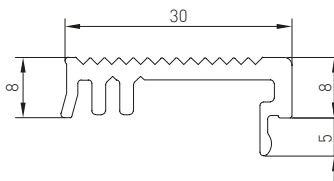
WESER D 8 ABS	COPERTURA COVER	COLORE COLOUR	CF PK
	ABS	nero black	3 ML

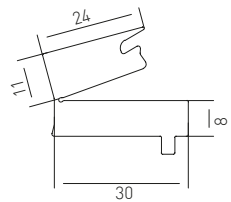
WESER TD 8/11	TERMINALE END COVER	COLORE COLOUR	CF PK
	EPDM	nero black	1 ML

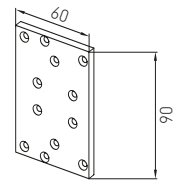
WESER SH 70	PIATTINA FASTENING PART	COLORE COLOUR	CF PK
	ALU	argento silver	1 PZ

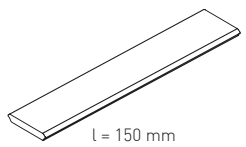
WESER BS 21.4	PIATTINA THRESHOLD SUPPORT	COLORE COLOUR	CF PK
	ALU	argento silver	1 PZ

SOGLIE DA INTERNO E ACCESSORI
THRESHOLDS FOR INTERIOR AND ACCESSORIES

INT P 60-15

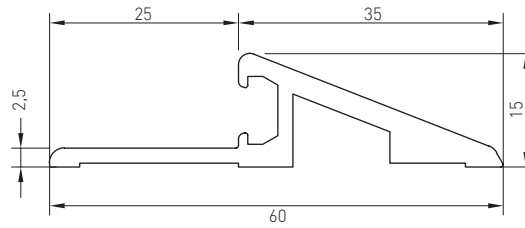

INT P 60-15	CODICE CODE	COLORE COLOUR	CF PK
	INT P 60-15 EV1	argento silver	6 ML
	INT P 60-15 G214	bronzo bronze	6 ML

INT M5x37	VITE DI FISSAGGIO ADJUSTING SCREW	COLORE COLOUR	CF PK
	acciaio inossidabile stainless steel	grezzo raw	1 PZ

DICHTUNG TD 15	GUARNIZIONE GASKET	COLORE COLOUR	CF PK
	EPDM	nero black	1 ML

INT TD 20	GUARNIZIONE GASKET	COLORE COLOUR	CF PK
	EPDM	nero black	1 ML

INT TD 32	GUARNIZIONE GASKET	COLORE COLOUR	CF PK
	EPDM	nero black	1 ML

PROFILO DI CHIUSURA PER ALZANTE SCORREVOLE E ACCESSORI
 LOCKING PROFILE FOR LIFTING SLIDING DOORS AND ACCESSORIES

MV 26.11

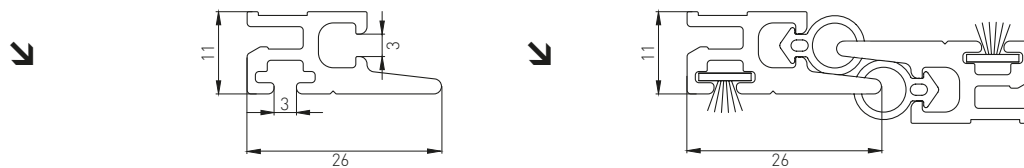

MV 26.11		COLORE COLOUR	CF PK
	ALU	argento silver	6 ML

HA 3010	GUARNIZIONE GASKET	COLORE COLOUR	CF PK
	EPDM	nero black	1 ML

RB 1	SPAZZOLINO 5 MM BRUSH STRIP 5 MM	COLORE COLOUR	CF PK
	PVC	nero black	1 ML

RB 2	SPAZZOLINO 7 MM BRUSH STRIP 7 MM	COLORE COLOUR	CF PK
	PVC	nero black	1 ML

RB 2 MS	SPAZZOLINO 8 MM BRUSH STRIP 8 MM	COLORE COLOUR	CF PK
<p>con ponte with bridge</p>	PVC	nero black	1 ML

GRONDALINI
WEATHER BAR SILL

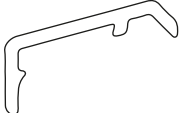
FP 18	GRONDALINO WEATHER BAR SILL		COLORE COLOUR	CF PK
	ALU	FP 18 GREZZO	grezzo raw	6 ML
	ALU	FP 18 EV1	argento silver	6 ML
	ALU	FP 18 G214	bronzo bronze	6 ML
	ALU	FP 18 RAL	ral ral	6 ML

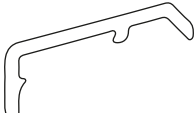
FP 20	GRONDALINO WEATHER BAR SILL		COLORE COLOUR	CF PK
	ALU	FP 20 GREZZO	grezzo raw	6 ML
	ALU	FP 20 EV1	argento silver	6 ML
	ALU	FP 20 G214	bronzo bronze	6 ML
	ALU	FP 20 RAL	ral ral	6 ML

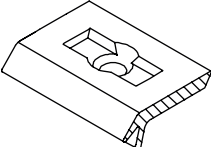
KLIPSHALTER FP 16/20	CLIP CLIP HOLDER		COLORE COLOUR	CF PK
	NYLON	KLIPSHALTER FP 16/20	bianco white	1 PZ

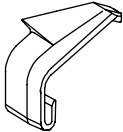
FP/18	TERMINALE END COVER		COLORE COLOUR	CF PK
	EPDM	FP/18 B	bianco white	2 PZ
	EPDM	FP/18 M	marrone brown	2 PZ
	EPDM	FP/18 A	argento silver	2 PZ

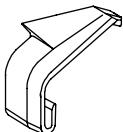
FP/20	TERMINALE END COVER		COLORE COLOUR	CF PK
	EPDM	FP/20 B	bianco white	2 PZ
	EPDM	FP/20 M	marrone brown	2 PZ
	EPDM	FP/20 A	argento silver	2 PZ



GUARNIZIONI
GASKETS

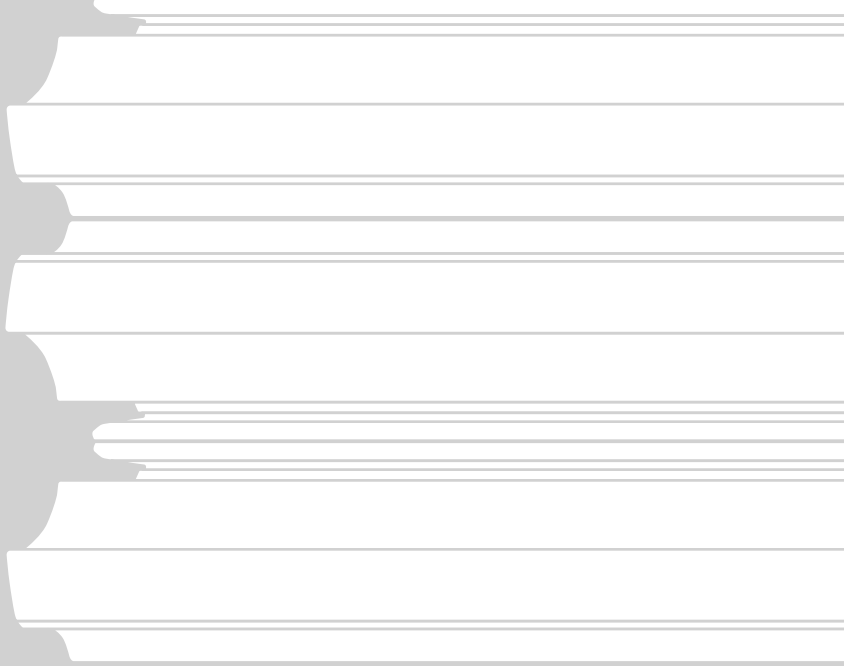





GUARNIZIONI PRINCIPALI
MAIN GASKETS

GC-5120040220			COLORE COLOUR	CF PK	↓ triestruso tri-extruded ↓ aria 5 mm battuta 12 mm cava 4x8 mm
	TP-S	GCB5120040220	bianco white	220 ML	
	TP-S	GCG5120040220	grigio grey	220 ML	
	TP-S	GCM5120040220	marrone brown	220 ML	
	TP-S	GCN5120040220	nero black	220 ML	

GL-5120010220		[ECONOMICA LOW PRICE]	COLORE COLOUR	CF PK	↓ triestruso tri-extruded ↓ aria 5 mm battuta 12 mm cava 4x8 mm
	TP-S	GLB5120010220	bianco white	220 ML	
	TP-S	GLG5120010220	grigio grey	220 ML	
	TP-S	GLM5120010220	marrone brown	220 ML	
	TP-S	GLN5120010220	nero black	220 ML	

GD-5120030280			COLORE COLOUR	CF PK	↓ triestruso tri-extruded ↓ aria 5 mm battuta 12 mm cava 4x8 mm
	TP-S	GDB5120030280	bianco white	280 ML	
	TP-S	GDM5120030280	marrone brown	280 ML	
	TP-S	GDN5120030280	nero black	280 ML	

GUARNIZIONE MORBIDA PER PORTONI SOFT GASKET FOR FRONTDOOR					
GE-5120010220			COLORE COLOUR	CF PK	↓ triestruso tri-extruded ↓ aria 5 mm battuta 12 mm cava 4x8 mm
	TP-S	GEB5120010220	bianco white	220 ML	
	TP-S	GEM5120010220	marrone brown	220 ML	

GF-5120010220			COLORE COLOUR	CF PK	↓ triestruso tri-extruded ↓ aria 5 mm battuta 12 mm cava 4x8 mm
	TP-S	GFB5120010220	bianco white	220 ML	
	TP-S	GFG5120010220	grigio grey	220 ML	
	TP-S	GFM5120010220	marrone brown	220 ML	
	TP-S	GFN5120010220	nero black	220 ML	

GC-6040030400			COLORE COLOUR	CF PK	↓ triestruso tri-extruded ↓ aria 6 mm cava 3x5 mm
	TP-S	GCB6040030400	bianco white	400 ML	
	TP-S	GCG6040030400	grigio grey	400 ML	
	TP-S	GCM6040030400	marrone brown	400 ML	
	TP-S	GCN6040030400	nero black	400 ML	

GL-6040010400		(ECONOMICA LOW PRICE)	COLORE COLOUR	CF PK	↓ triestruso tri-extruded ↓ aria 6 mm cava 3x5 mm
	TP-S	GLB6040010400	bianco white	400 ML	
	TP-S	GLG6040010400	grigio grey	400 ML	
	TP-S	GLM6040010400	marrone brown	400 ML	
	TP-S	GLN6040010400	nero black	400 ML	

GC-6100030340			COLORE COLOUR	CF PK	↓ triestruso tri-extruded ↓ aria 6 mm battuta 10 mm cava 3x5 mm
	TP-S	GCB6100030340	bianco white	340 ML	
	TP-S	GCG6100030340	grigio grey	340 ML	
	TP-S	GCM6100030340	marrone brown	340 ML	
	TP-S	GCN6100030340	nero black	340 ML	

GL-6100010340		(ECONOMICA LOW PRICE)	COLORE COLOUR	CF PK	↓ triestruso tri-extruded ↓ aria 6 mm battuta 10 mm cava 3x5 mm
	TP-S	GLB6100010340	bianco white	340 ML	
	TP-S	GLG6100010340	grigio grey	340 ML	
	TP-S	GLM6100010340	marrone brown	340 ML	
	TP-S	GLN6100010340	nero black	340 ML	

GD-6100030310			COLORE COLOUR	CF PK	↓ triestruso tri-extruded ↓ aria 6 mm battuta 10 mm cava 3x5 mm
	TP-S	GDB6100030310	bianco white	310 ML	
	TP-S	GDM6100030310	marrone brown	310 ML	
	TP-S	GDN6100030310	nero black	310 ML	

GF-6100010340			COLORE COLOUR	CF PK	↓ triestruso tri-extruded ↓ aria 6 mm battuta 10 mm cava 3x5 mm
	TP-S	GFB6100010240	bianco white	240 ML	
	TP-S	GFG6100010240	grigio grey	240 ML	
	TP-S	GFM6100010240	marrone brown	240 ML	
	TP-S	GFN6100010240	nero black	240 ML	

GC-5120040220

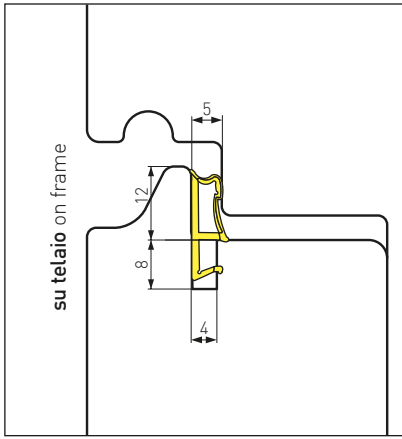

GF-5120010220

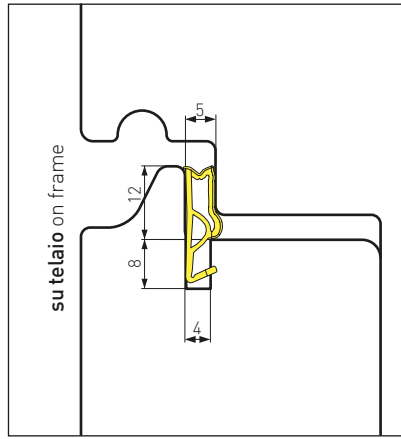

GC-6040030400

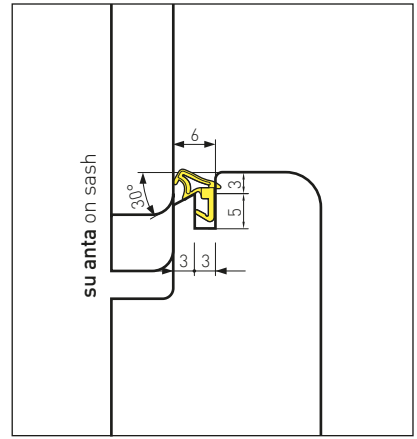

GC-6100030340

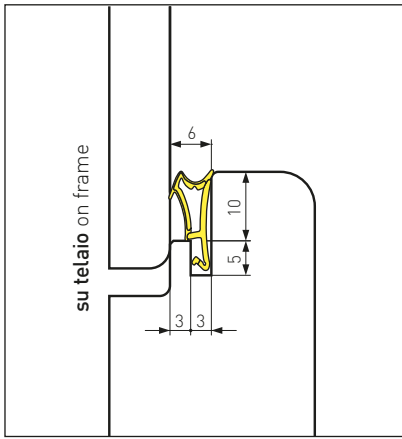

GD-6100030310

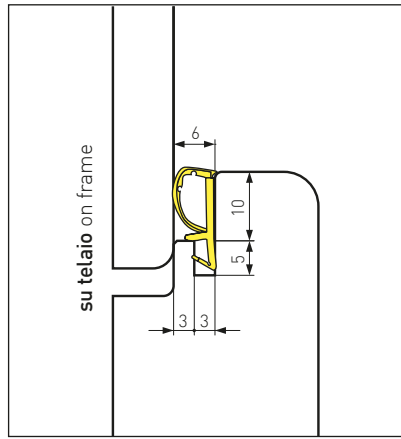

GF-6100010340

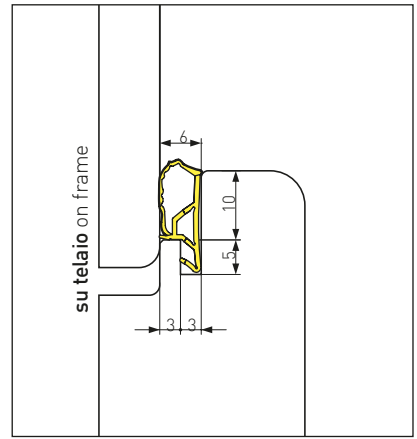

GA-1860010220

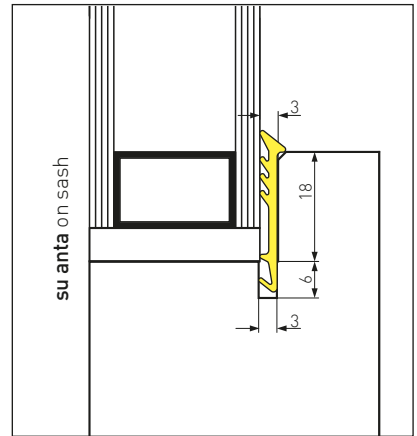

GA-8600020200

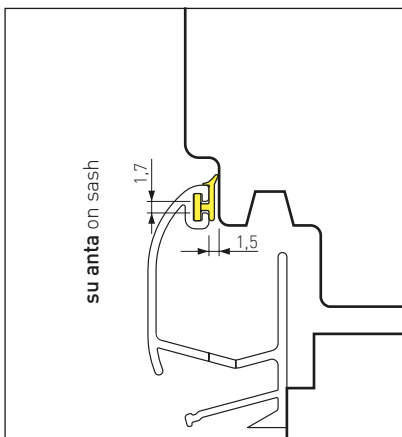

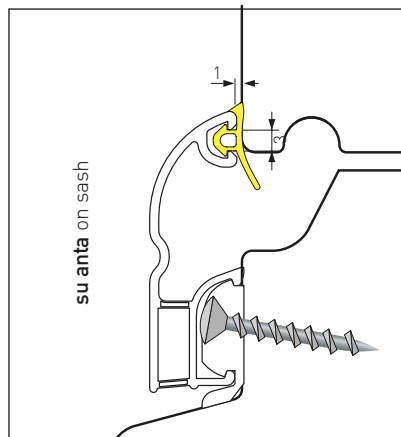

GA-9100030450

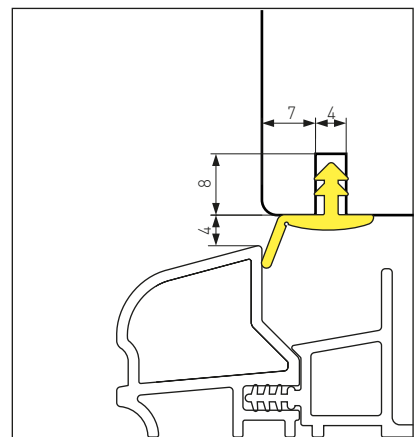

GA-9190020215



GA-1860010220			COLORE COLOUR	CF PK	↓ monoestruso mono-extruded ↓ spessore 3 mm battuta 18 mm cava 3x6 mm
 CE 10	TPV	GAB1860010220	bianco white	220 ML	
	TPV	GAM1860010220	marrone brown	220 ML	
	TPV	GAN1860010220	nero black	220 ML	





GA-2060010220			COLORE COLOUR	CF PK	↓ monoestruso mono-extruded ↓ spessore 3 mm battuta 20 mm cava 3x6 mm
 CE 10	TPV	GAB2060010220	bianco white	220 ML	
	TPV	GAM2060010220	marrone brown	220 ML	
	TPV	GAN2060010220	nero black	220 ML	



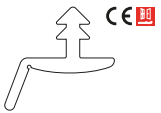

GA-8600020200			COLORE COLOUR	CF PK	↓ coestruso co-extruded ↓ spessore 1 mm cava 2 mm
 CE 10	TP-S	GAB8600020200	bianco white	200 ML	
	TP-S	GAG8600020200	grigio grey	200 ML	
	TP-S	GAM8600020200	marrone brown	200 ML	
	TP-S	GAN8600020200	nero black	200 ML	

GE-8600010200			COLORE COLOUR	CF PK	↓ monoestrusa mono-extruded ↓ spessore 1 mm cava 2 mm
	TP-S	GEB8600010200	bianco white	200 ML	
	TP-S	GEG8600010200	grigio grey	200 ML	
	TP-S	GEM8600010200	marrone brown	200 ML	
	TP-S	GEN8600010200	nero black	200 ML	



GA-9100030450			COLORE COLOUR	CF PK	↓ monoestruso mono-extruded ↓ spessore 1 mm cava 3 mm
 CE 10	TP-S	GAB9100030450	bianco white	450 ML	
	TP-S	GAG9100030450	grigio grey	450 ML	
	TP-S	GAM9100030450	marrone brown	450 ML	
	TP-S	GAN9100030450	nero black	450 ML	

GA-9190020215			COLORE COLOUR	CF PK	↓ monoestruso mono-extruded ↓ battuta 11 mm cava 4x6 mm
 CE 10	TP-S	GAB9190020215	bianco white	215 ML	
	TP-S	GAM9190020215	marrone brown	215 ML	
	TP-S	GAN9190020215	nero black	215 ML	



GA-9070020480			COLORE COLOUR	CF PK	 monoestruso mono-extruded  battuta 1 mm cava 3x7 mm
 	TP-S	GAB9070020480	bianco white	480 ML	
	TP-S	GAM9070020480	marrone brown	480 ML	
	TP-S	GAN9070020480	nero black	480 ML	

GA-9080020480			COLORE COLOUR	CF PK	 monoestruso mono-extruded  battuta 1 mm cava 3x7 mm
 	TP-S	GAB9080020480	bianco white	480 ML	
	TP-S	GAM9080020480	marrone brown	480 ML	
	TP-S	GAN9080020480	nero black	480 ML	

GE-5040030400			COLORE COLOUR	CF PK	 coestruso co-extruded  spessore 6 mm cava 2,2x6 mm
 	TP-S	GEB5040030400	bianco white	400 ML	
	TP-S	GEG5040030400	grigio grey	400 ML	
	TP-S	GEM5040030400	marrone brown	400 ML	
	TP-S	GEN5040030400	nero black	400 ML	
	TP-S	GET5040030400	trasparente transparent	400 ML	

GV-5040010200			COLORE COLOUR	CF PK	 coestruso co-extruded  spessore 6 mm cava 2,2x6 mm
	EPDM	GVN5040010200	nero black	200 ML	

GA-4450010350			COLORE COLOUR	CF PK	 monoestruso mono-extruded  battuta 1 mm cava 4x6,5 mm
	TPV	GAB4450010350	bianco white	350 ML	
	TPV	GAM4450010350	marrone brown	350 ML	
	TPV	GAN4450010350	nero black	350 ML	

GC-4110020320			COLORE COLOUR	CF PK	 triestruso tri-extruded  aria 4 mm battuta 11 mm cava 4x8 mm
	TP-S	GCB4110020320	bianco white	320 ML	
	TP-S	GCM4110020320	marrone brown	320 ML	
	TP-S	GCN4110020320	nero black	320 ML	



GA-9070020480

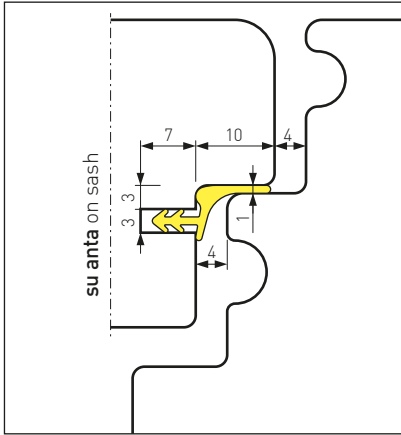

GE-5040030400

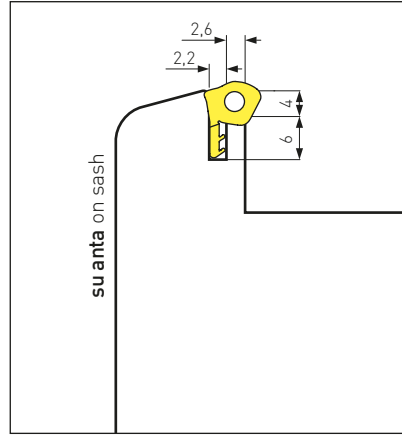

GC-4150020250

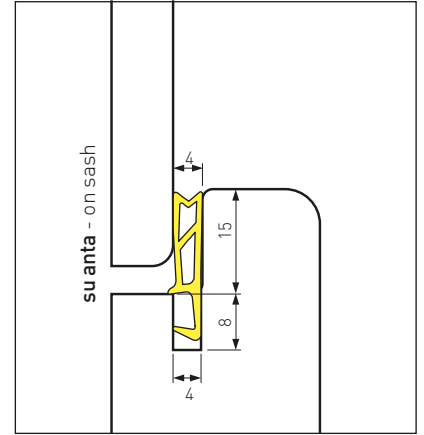

GD-4110010300 *			COLORE COLOUR	CF PK	↓ triestruso tri-extruded ↓ aria 4 mm battuta 11 mm cava 4x8 mm
	TPV	GDB4110010300	bianco white	300 ML	
	TPV	GDM4110010300	marrone brown	300 ML	
	* FINO A ESAURIMENTO SCORTE WHILE SUPPLIES LAST				





GC-4140020240			COLORE COLOUR	CF PK	↓ triestruso tri-extruded ↓ aria 4 mm battuta 14 mm cava 4x8 mm
	TP-S	GCB4140020240	bianco white	240 ML	
	TP-S	GCM4140020240	marrone brown	240 ML	
	TP-S	GCM4140020240	nero black	240 ML	



GC-4150020230			COLORE COLOUR	CF PK	↓ triestruso tri-extruded ↓ aria 4 mm battuta 15 mm cava 4x8 mm
	TP-S	GCB4150020230	bianco white	230 ML	
	TP-S	GCM4150020230	marrone brown	230 ML	
	TP-S	GCM4150020230	nero black	230 ML	





GA-4180010200			COLORE COLOUR	CF PK	↓ monoestruso mono-extruded ↓ aria 4 mm battuta 18 mm cava 4x8 mm
	TPV	GAB4180010200	bianco white	200 ML	
	TPV	GAM4180010200	marrone brown	200 ML	

GC-4180020180			COLORE COLOUR	CF PK	↓ triestruso tri-extruded ↓ aria 4 mm battuta 18 mm cava 4x8 mm
	TP-S	GCB4180020180	bianco white	200 ML	
	TP-S	GCM4180020180	marrone brown	200 ML	
	TP-S	GCN4180020180	nero black	200 ML	

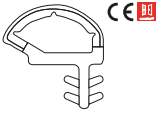
GA-5150010225			COLORE COLOUR	CF PK	↓ monoestruso mono-extruded ↓ aria 5 mm battuta 15 mm cava 5x8 mm
	TPV	GAB5150010225	bianco white	225 ML	
	TPV	GAM5150010225	marrone brown	225 ML	

GD-3100020400			COLORE COLOUR	CF PK	↓ triestruso tri-extruded ↓ aria 4 mm battuta 10 mm cava 3,2x4,2 mm
	TP-S	GDB3100020400	bianco white	400 ML	
	TP-S	GDM3100020400	marrone brown	400 ML	
	TP-S	GDN3100020400	nero black	400 ML	

GA-3120020300			COLORE COLOUR	CF PK	↓ monoestruso mono-extruded ↓ battuta 12 mm cava 4x8 mm
	TP-S	GAB3120020300	bianco white	300 ML	
	TP-S	GAM3120020300	marrone brown	300 ML	
	TP-S	GAN3120020300	nero black	300 ML	

GA-3125020300			COLORE COLOUR	CF PK	↓ monoestruso mono-extruded ↓ battuta 12 mm cava 4x8 mm
	TP-S	GAB3125020300	bianco white	300 ML	
	TP-S	GAM3125020300	marrone brown	300 ML	
	TP-S	GAN3125020300	nero black	300 ML	

GA-3310020100			COLORE COLOUR	CF PK	↓ monoestruso mono-extruded ↓ aria 3 mm cava 3x7 mm
	TP-S	GAB3310020100	bianco white	100 ML	
	TP-S	GAM3310020100	marrone brown	100 ML	

GA-3320020340		COLORE COLOUR	CF PK	↓ monoestruso mono-extruded ↓ aria 3 mm cava 3x6 mm	
	TP-S	GAB3320020340	bianco white		340 ML
	TP-S	GAM3320020340	marrone brown		340 ML

GE-4300020450		COLORE COLOUR	CF PK	↓ coestruso co-extruded ↓ aria 3 mm cava 4x6,5 mm	
	TP-S	GEB4300020450	bianco white		450 ML
	TP-S	GEM4300020450	marrone brown		450 ML
	TP-S	GEN4300020450	nero black	450 ML	

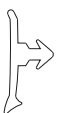
GE-2140010500		COLORE COLOUR	CF PK	↓ coestruso co-extruded ↓ battuta 14 mm	
	TP-S	GEB2140010500	bianco white		500 ML
	TP-S	GEM2140010500	marrone brown		500 ML
	TP-S	GEN2140010500	nero black	500 ML	

GD-3100010400

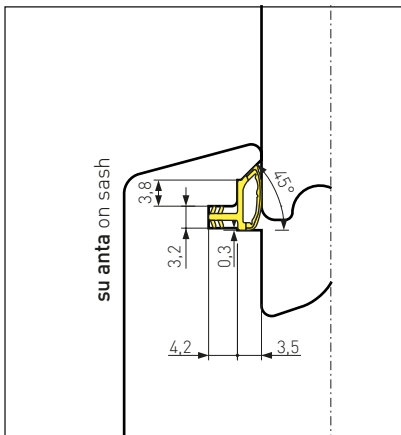

GA-3320020190

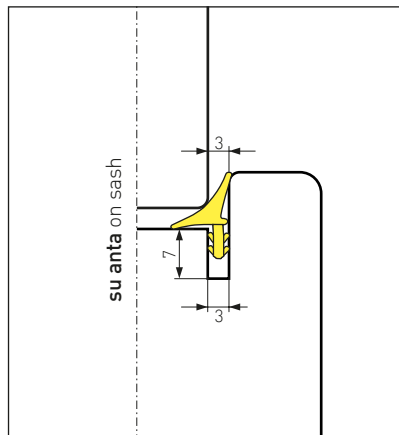

GE-4300020450

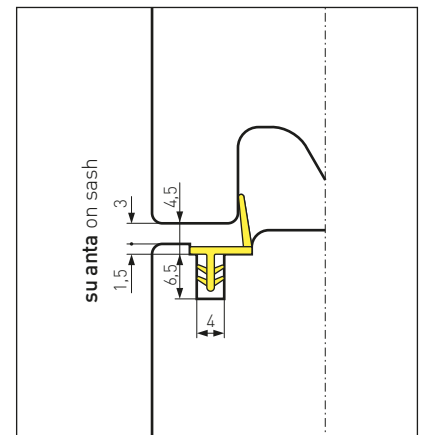

GA-3120020300

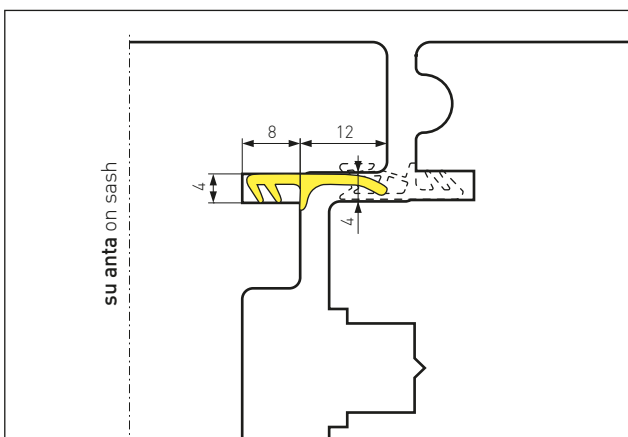

GA-3125020300

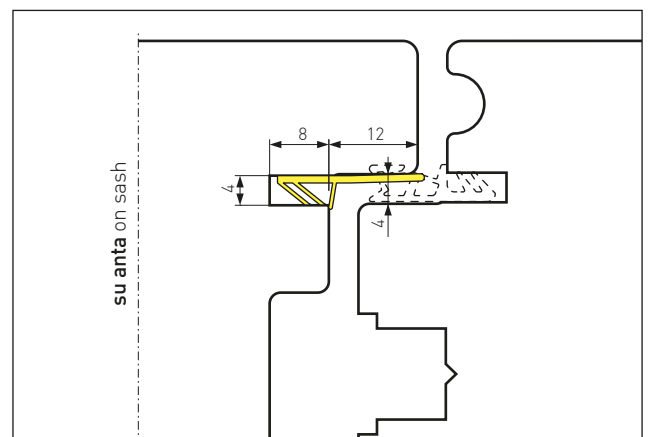



GUARNIZIONI PORTE
GASKETS FOR DOORS

GP-8300010250			COLORE COLOUR	CF PK	↘ coestruso co-extruded ↘ aria 3 mm battuta 10 mm cava 3,5x6 mm
	PVC	GPB8300010250	bianco white	250 ML	
	PVC	GPM8300010250	marrone brown	250 ML	

GA-8300010300 *			COLORE COLOUR	CF PK	↘ monoestruso mono-extruded ↘ aria 3 mm battuta 10 mm cava 3,5x6 mm
	TPV	GAB8300010300	bianco white	300 ML	
	* FINO A ESAURIMENTO SCORTE WHILE SUPPLIES LAST				

GP-8310010340			COLORE COLOUR	CF PK	↘ monoestruso mono-extruded ↘ aria 3 mm battuta 10 mm cava 3,2x7 mm
	PVC	GPB8310020340	bianco white	340 ML	
	PVC	GPM8310020340	marrone brown	340 ML	

GP-8400010300			COLORE COLOUR	CF PK	↘ monoestruso mono-extruded ↘ aria 3 mm battuta 10 mm cava 3,5x6 mm
	PVC	GPB8400010300	bianco white	300 ML	
	PVC	GPM8400010300	marrone brown	300 ML	

GE-8400010250 *			COLORE COLOUR	CF PK	↘ coestruso co-extruded ↘ aria 3 mm battuta 10 mm cava 3,5x6 mm
	TPV	GEB8400010250	bianco white	250 ML	
	* FINO A ESAURIMENTO SCORTE WHILE SUPPLIES LAST				

GE-8460010250 *			COLORE COLOUR	CF PK	↘ coestruso co-extruded ↘ aria 3 mm battuta 10 mm cava 3,5x6 mm
	TPV	GEB8460010250	bianco white	250 ML	
	* FINO A ESAURIMENTO SCORTE WHILE SUPPLIES LAST				

GP-8470010270			COLORE COLOUR	CF PK	↘ coestruso co-extruded ↘ aria 4 mm battuta 10 mm cava 3x8 mm
	PVC	GPB8470010270	bianco white	270 ML	
	PVC	GPM8470010270	marrone brown	270 ML	

GP-8500010250			COLORE COLOUR	CF PK	↘ coestruso co-extruded ↘ aria 3 mm battuta 10 mm cava 3,5x6 mm
	PVC	GPB8500010250	bianco white	250 ML	
	PVC	GPM8500010250	marrone brown	250 ML	



GP-8300010300

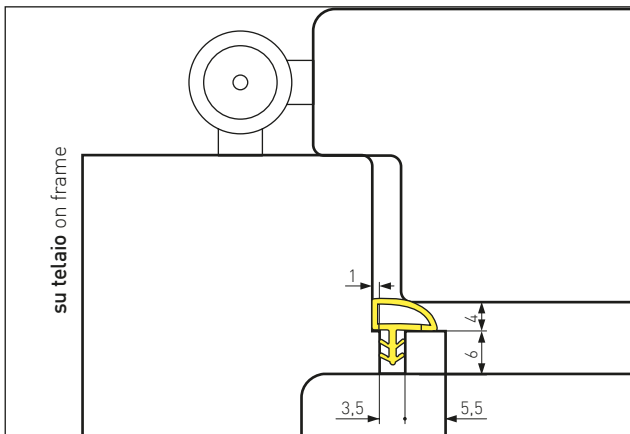

GP-8310010340

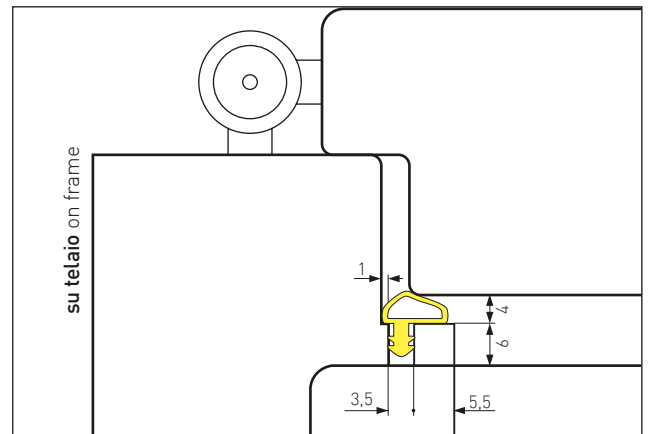

GP-8400020300

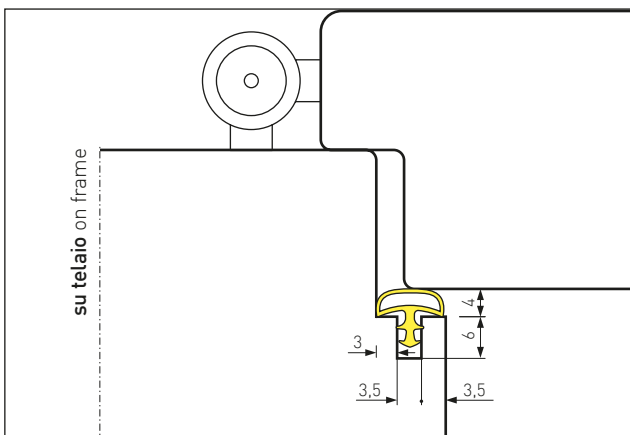

GP-8470010270

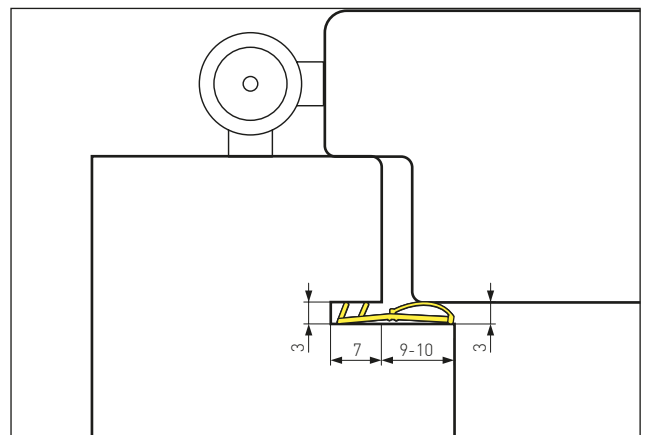

GUARNIZIONI SPECIALI E ACCESSORI
SPECIAL GASKETS AND ACCESSORIES

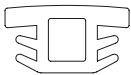
GUARNIZIONE CAVA FERRAMENTA METALWARE GASKET PLUG				
GP-1300010200		COLORE COLOUR	CF PK	↘ monoestruso mono-extruded
	GPA1300010200	metallizzato silver metal	200 ML	
	GPG1300010200	grigio grey	200 ML	

SPAZZOLINO BRUSH STRIP					
GAX8610010322		SPAZZOLINO BRUSH STRIP	COLORE COLOUR	CF PK	↘ aria 12 mm cava 3x7 mm
	PVC	GAX8610010322	bianco white	322 ML	
	TPV				

GUARNIZIONE IN SILICONE: RISTRUTTURAZIONE VECCHIE FINESTRE SILICONE GASKET: RENOVATION ON OLD WINDOWS					
GS-6350010200		COLORE COLOUR	CF PK	↘ monoestruso mono-extruded ↘ aria 5-6 mm cava 3x5 mm	
	SILI- CONE	GSB6350010200	bianco white		200 ML
		GSM6350010200	marrone brown		200 ML
		GST6350010200	trasparente transparent	200 ML	

GUARNIZIONE FERMAVETRO GLASS GASKET					
GA-3630010300		FERMAVETRO GLASS GASKET	COLORE COLOUR	CF PK	↘ aria 3 mm battuta 3 mm
	TPV	GAB3630010300	bianco white	300 ML	
	TPV	GAM3630010300	marrone brown	300 ML	
	TPV	GAN3630010300	nero black	300 ML	

→ combinate con profili fermavetro
combined with glass profiles
↘ p. 57

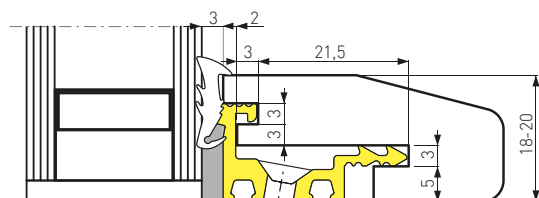
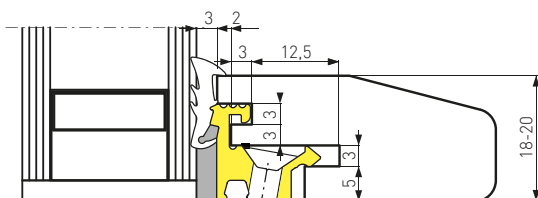

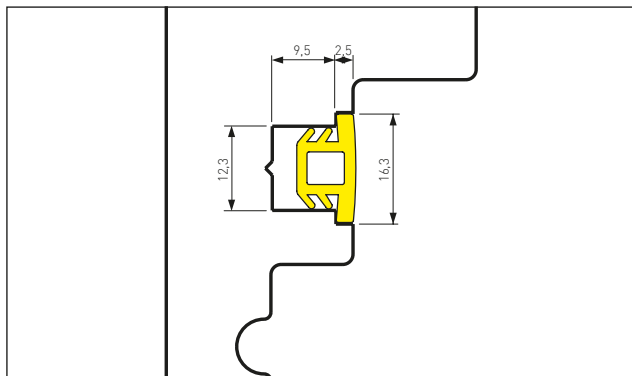
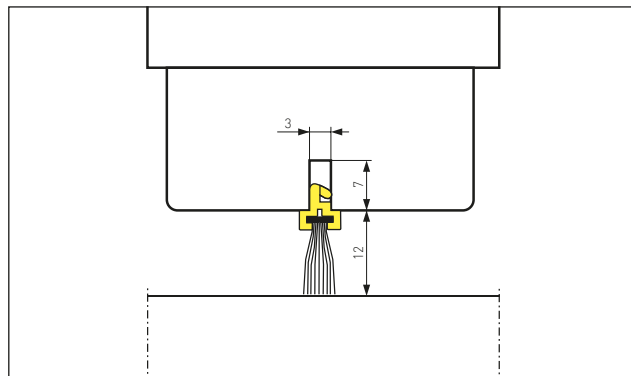
**GP-1300010200****GAX8610010322****FORBICI PER GUARNIZIONI** SCISSORS GASKET**4104/VR**

CF PK



4104/VR

taglio a V V-cut

1 PZ

 ↓
 su anta
 on sash
FORBICI PER GUARNIZIONI SCISSORS GASKET**4104/YR**

CF PK



4104/YR

taglio a Y Y-cut

1 PZ

 ↓
 su telaio
 on frame
TERMINALE PER GUARNIZIONI GASKETS END COVER**FP-512A010200**

COLORE COLOUR

CF PK

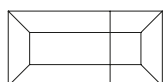

TPE

FPB512A010200

bianco white

200 PZ

TPE

FPN512A010200

marrone brown

200 PZ

TPE

FPS512A010200

nero black

200 PZ

 terminale per guarnizione aria 5 mm
 su chiusura centrale
 end cover for gasket (kerft 5 mm)
 for two sashes window

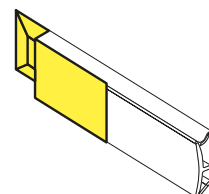
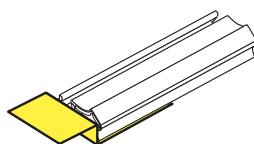
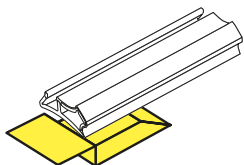
APPLICAZIONE A
 APPLICABLE TO
 G--512

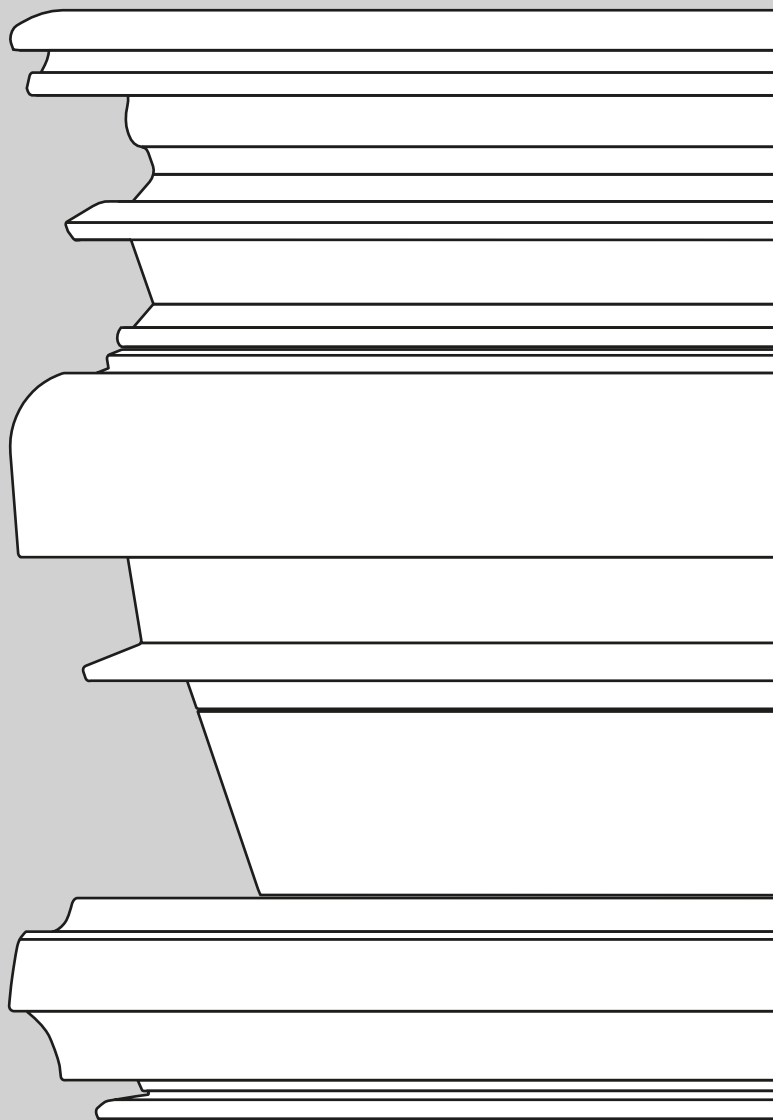

DGT SRL

ACCESSORI CASCADING FREUD

SISTEMI E TECNOLOGIE PER LA LAVORAZIONE DEL LEGNO

Via San Damiano, 3 - 60020 Polverigi (AN)

t. + 39 071 9069517 - f. + 39 071 9069517

dgtsrl@gmail.com